

Article datasheet

Hole Grommet 6.0/12.0-3.0mm Polychloropren (Neopren) black

Article-No.: 014.70.597

Manufacturer: SES-Sterling

Manufacturer article-no.: 0252 0025 010



Image may be similar

Color:	Black
Inner Diameter [mm]:	6
Material:	CR - Polychloroprene
Material Group:	Plastic
Max. Panel Thickness [mm]:	1.8
Mounting Hole [mm]:	12
Weight:	1.35g
Conformities:	



You can find all information on the web on our article detail page

[Hole Grommet 6.0/12.0-3.0mm Polychloropren \(Neopren\) black](#)

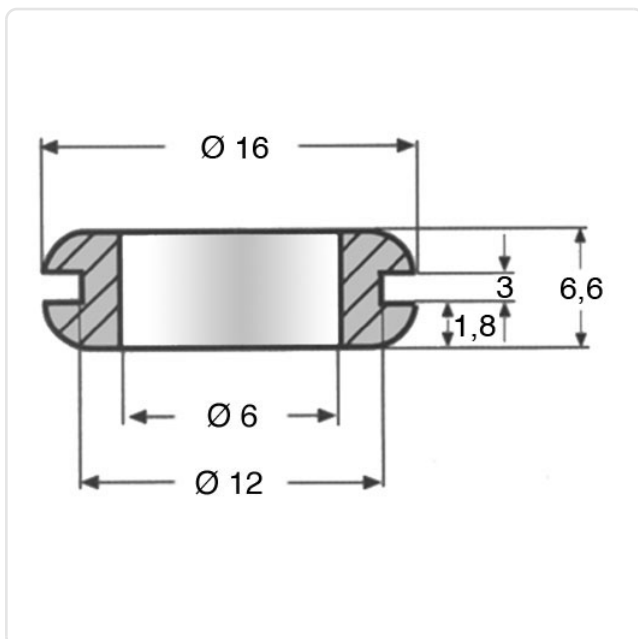

Would you like individual advice?

We look forward to your email to products@ettinger.de.

Subject to change and errors.