

Article datasheet

## Standoff Polyamide 6.6 Black M/F AF6x6 F=M3x4 M=M3x4 w/o Undercut

Article-No.: 005.43.406



Image may be similar

AF / OD [mm]:	6
Color:	Black
Female Thread Length [mm]:	4
Female Thread Size:	M3
Flammability Class:	UL94-HB
Length [mm]:	6
Male Thread Length [mm]:	4
Male Thread Size:	M3
Material:	PA 6.6
Material Group:	Plastic
Profile:	Hexagonal
Undercut:	No
Weight:	0.21g
Conformities:	

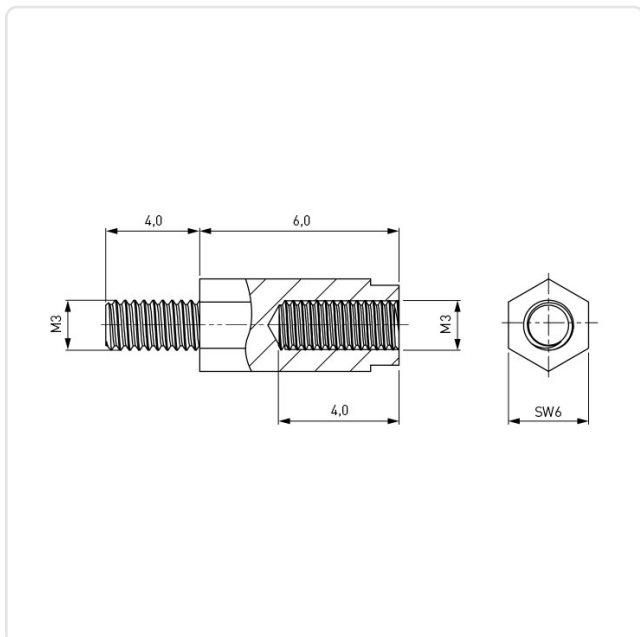

You can find all information on the web on our article detail page

[Standoff Polyamide 6.6 Black M/F AF6x6 F=M3x4 M=M3x4 w/o Undercut](#)

Would you like individual advice?

We look forward to your email to [products@ettinger.de](mailto:products@ettinger.de).

Subject to change and errors.