

Article datasheet

Countersunk Screw ISO14581 M6x16 A4 Plain Stainless Steel Torx

Article-No.: 001.60.669



Image may be similar

Actuator Size:	Torx T30
DIN/ISO:	ISO14581
Drive Type:	TORX
Finish:	Plain
Head Diameter [mm]:	11.3
Head Height [mm]:	3.3
Head Shape:	Countersunk Head
Length [mm]:	16
Material:	Stainless Steel AISI 316 / A4
Material Group:	Stahl rostfrei
Thread Size:	M6
Weight:	0.34g
Conformities:	

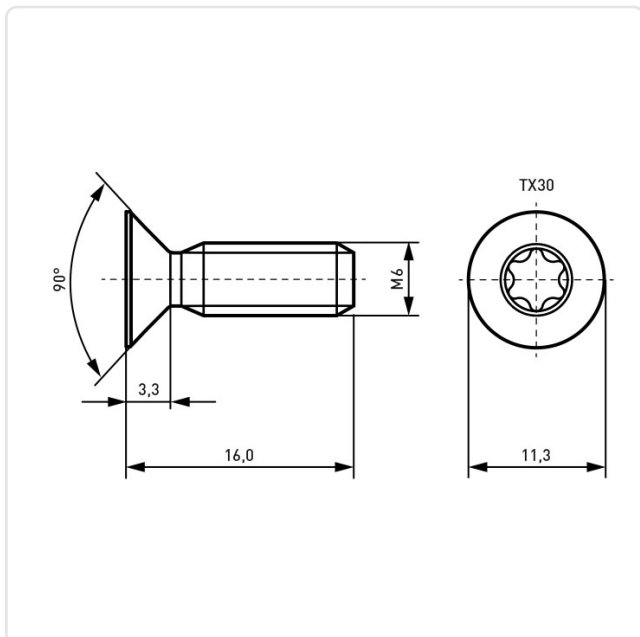

You can find all information on the web on our article detail page

[Countersunk Screw ISO14581 M6x16 A4 Plain Stainless Steel Torx](#)

Would you like individual advice?

We look forward to your email to products@ettinger.de.

Subject to change and errors.