

Article datasheet

**Weld Nut DIN929 M4 Plain Steel Hexagon**

Article-No.: 002.31.041

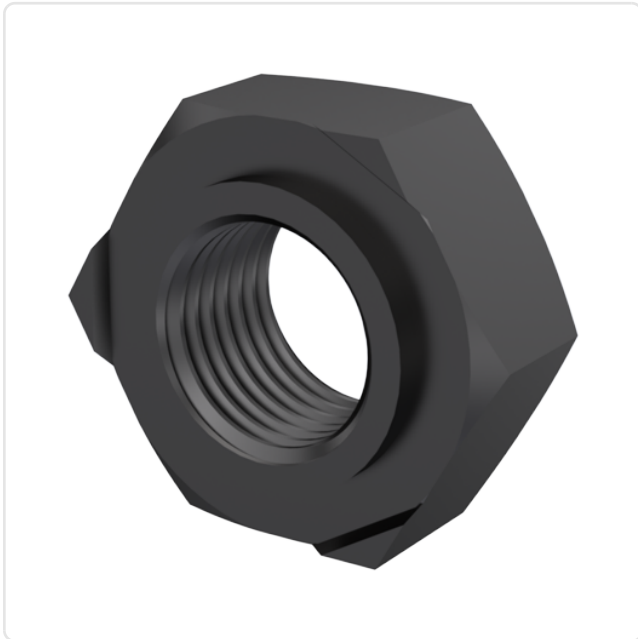
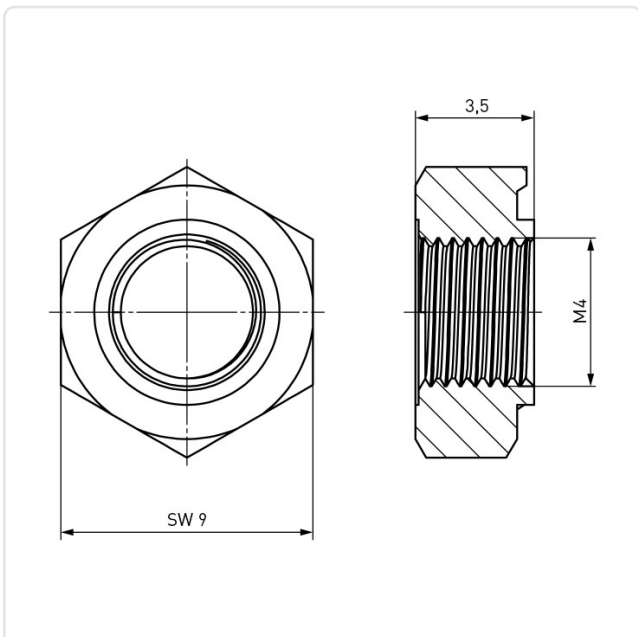

Image may be similar

AF / OD [mm]: 9  
DIN/ISO: DIN929  
Finish: Plain  
Height [mm]: 3.5  
Material: Steel  
Material Group: Steel  
Thread Size: M4  
Conformities:



You can find all information on the web on our article detail page  
[Weld Nut DIN929 M4 Plain Steel Hexagon](#)



Would you like individual advice?

We look forward to your email to [products@ettinger.de](mailto:products@ettinger.de).

Subject to change and errors.