



Article datasheet

Tubular Rivet DIN7340 B 2.5x0.3x6.0 Nickel-Plated Brass

Article-No.: 019.87.063



Image may be similar

DIN/ISO:	DIN7340B
Finish:	Nickel-Plated, 3 µm, E1E
Head Diameter [mm]:	4
Length [mm]:	6
Material:	Brass CW508L / CuZn37, lead-free
Material Group:	Brass
Rivet Diameter [mm]:	2.5
Wall Thickness [mm]:	0.30
Weight:	0.14g
Conformities:	  



You can find all information on the web on our article detail page

[Tubular Rivet DIN7340 B 2.5x0.3x6.0 Nickel-Plated Brass](#)

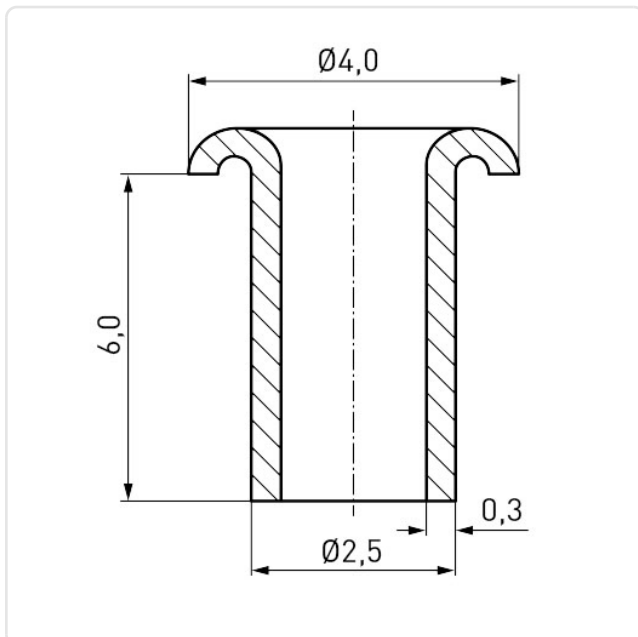

Would you like individual advice?

We look forward to your email to products@ettinger.de.

Subject to change and errors.