

Article datasheet

Countersunk Screw ISO7046 M4x14 Galvanized Steel 4.8 Cross Recessed

Article-No.: 082.22.411



Image may be similar

Actuator Size:	Phillips PH2
DIN/ISO:	ISO7046
Drive Type:	Cross Recess / Phillips-H
Finish:	Galvanized, Blue, 5 µm, A2K
Head Diameter [mm]:	7.5
Head Height [mm]:	2.2
Head Shape:	Countersunk Head
Length [mm]:	14
Material:	Steel 4.8
Material Group:	Stahl
Thread Size:	M4
Weight:	1.29g
Conformities:	

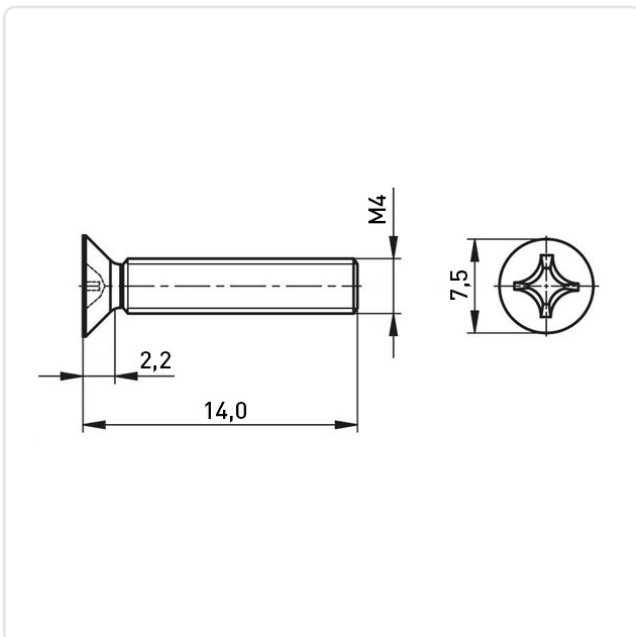

You can find all information on the web on our article detail page

[Countersunk Screw ISO7046 M4x14 Galvanized Steel 4.8 Cross Recessed](#)

Would you like individual advice?

We look forward to your email to products@ettinger.de.

Subject to change and errors.