

Article datasheet

Pan Head Screw ISO14583 M4x8 Stainless Steel A2 Hexalobular

Article-No.: 001.64.432



Image may be similar

Actuator Size:	Torx T20
DIN/ISO:	ISO14583
Drive Type:	TORX
Finish:	Plain
Head Diameter [mm]:	8
Head Height [mm]:	3.1
Head Shape:	Pan Head
Length [mm]:	8
Material:	Stainless Steel AISI 304 / A2
Material Group:	Stahl rostfrei
Thread Size:	M4
Weight:	1.32g
Conformities:	

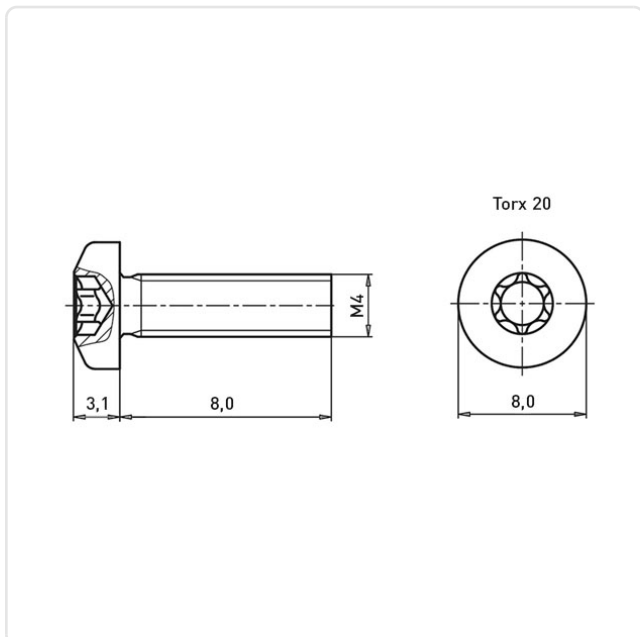

You can find all information on the web on our article detail page

[Pan Head Screw ISO14583 M4x8 Stainless Steel A2 Hexalobular](#)

Would you like individual advice?

We look forward to your email to products@ettinger.de.

Subject to change and errors.