

Article datasheet

Countersunk Screw ISO14581 M4x6 Galvanized Steel 8.8 Torx

Article-No.: 001.60.421



Image may be similar

Actuator Size:	Torx T20
DIN/ISO:	ISO14581
Drive Type:	TORX
Finish:	Galvanized, Blue, 5 µm, A2K
Head Diameter [mm]:	8.4
Head Height [mm]:	2.7
Head Shape:	Countersunk Head
Length [mm]:	6
Material:	Steel 8.8
Material Group:	Stahl
Thread Size:	M4
Weight:	0.7g
Conformities:	

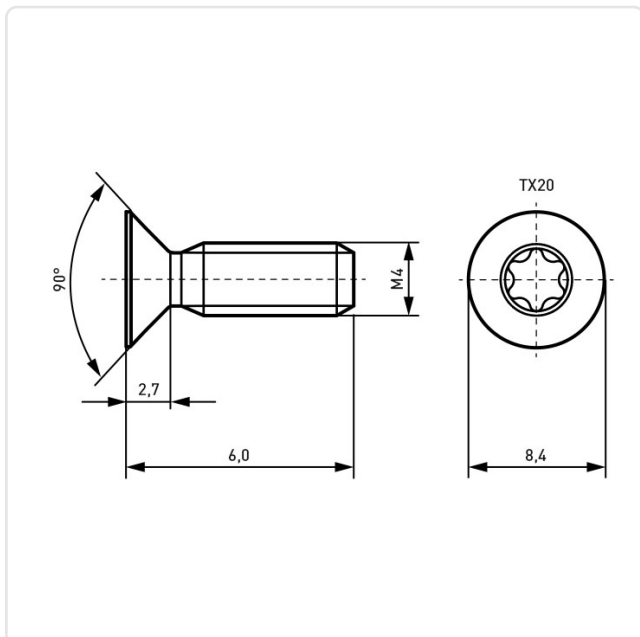

You can find all information on the web on our article detail page

[Countersunk Screw ISO14581 M4x6 Galvanized Steel 8.8 Torx](#)

Would you like individual advice?

We look forward to your email to products@ettinger.de.

Subject to change and errors.