

Article datasheet

## Pan Head Screw ISO1580 M3x8 Polyamide 6.6 Natural Slotted

Article-No.: 001.45.336



Color:	Natural
DIN/ISO:	ISO1580
Drive Type:	Slotted
Flammability Class:	UL94-V2
Head Diameter [mm]:	6
Head Height [mm]:	1.8
Head Shape:	Pan Head
Length [mm]:	8
Material:	PA 6.6
Material Group:	Plastic
Thread Size:	M3
Weight:	0.1g
Conformities:	



Image may be similar

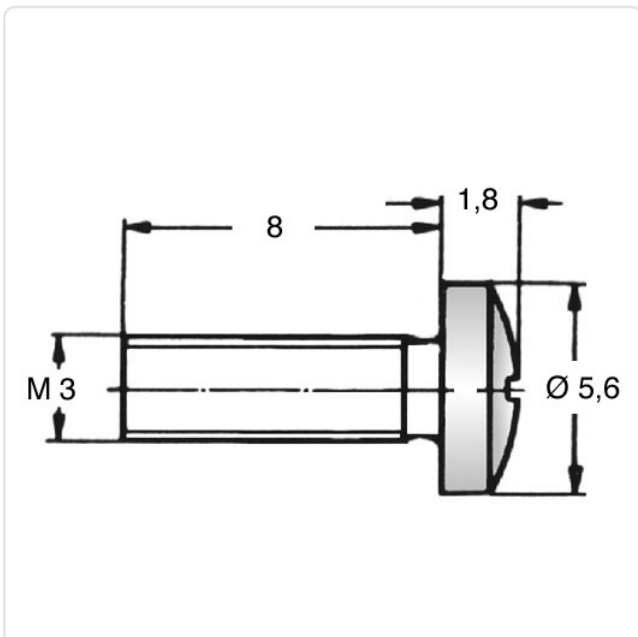

You can find all information on the web on our article detail page

[Pan Head Screw ISO1580 M3x8 Polyamide 6.6 Natural Slotted](#)

Would you like individual advice?

We look forward to your email to [products@ettinger.de](mailto:products@ettinger.de).

Subject to change and errors.