

Article datasheet

Thread Forming Screw DIN7500C M4x8 Galv. Steel Case Hardened Pozi Pan Head

Article-No.: 001.38.431



Image may be similar

Actuator Size:	Pozidriv PZ2
DIN/ISO:	DIN7500-C
Drive Type:	Cross Recess / Pozidriv-Z
Finish:	Galvanized, Blue, 5 µm, A2K
Head Diameter [mm]:	8
Head Height [mm]:	3.1
Head Shape:	Pan Head
Length [mm]:	8
Material:	Case-Hardened Steel
Material Group:	Steel
Thread Size:	M4
Thread Type:	Metric
Weight:	1.49g
Conformities:	

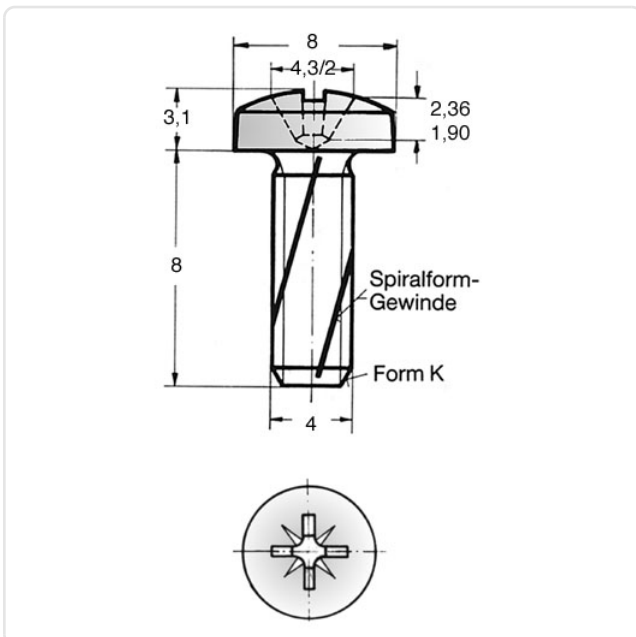

You can find all information on the web on our article detail page

[Thread Forming Screw DIN7500C M4x8 Galv. Steel Case Hardened Pozi Pan Head](#)

Would you like individual advice?

We look forward to your email to products@ettinger.de.

Subject to change and errors.