

Article datasheet

Diaphragm Grommet 9.0/15.0-2.0mm PVC black UL94-HB

Article-No.: 014.68.709

Manufacturer: SES-Sterling

Manufacturer article-no.: 0133 0351 010



Image may be similar

Color:	Black
Height [mm]:	20
Inner Diameter [mm]:	9
Material:	PVC - Polyvinyl Chloride
Material Group:	Plastic
Max. Panel Thickness [mm]:	2
Model:	Diaphragm Grommet, Closed
Mounting Hole [mm]:	15
Weight:	1.5g
Conformities:	<div style="display: flex; justify-content: space-around; align-items: center;"> <div style="border: 1px solid black; padding: 2px; text-align: center;">SVHC COMPLIANT ✓</div> <div style="border: 1px solid black; padding: 2px; text-align: center;">Reach COMPLIANT ✓</div> <div style="border: 1px solid black; padding: 2px; text-align: center;">RoHS COMPLIANT ✓</div> </div>



You can find all information on the web on our article detail page

[Diaphragm Grommet 9.0/15.0-2.0mm PVC black UL94-HB](#)

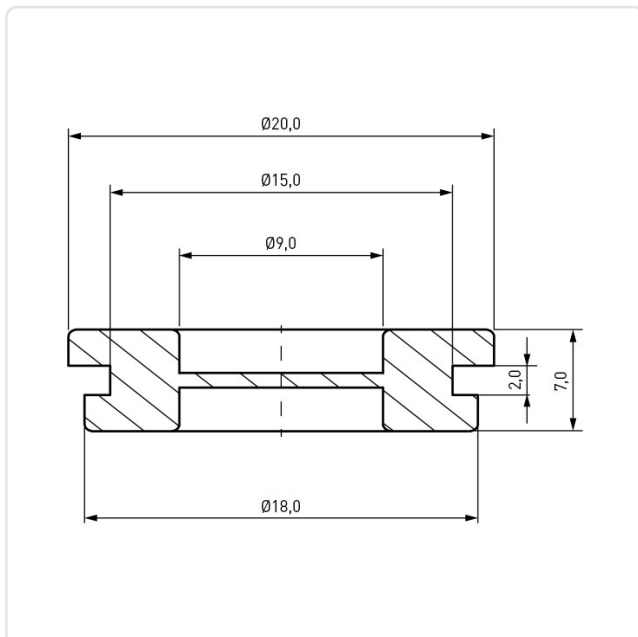

Would you like individual advice?

We look forward to your email to products@ettinger.de.

Subject to change and errors.