

Article datasheet

Button Head Screw ISO7380-1 M5x12 Stainless Steel A2 Hexalobular

Article-No.: 001.53.552

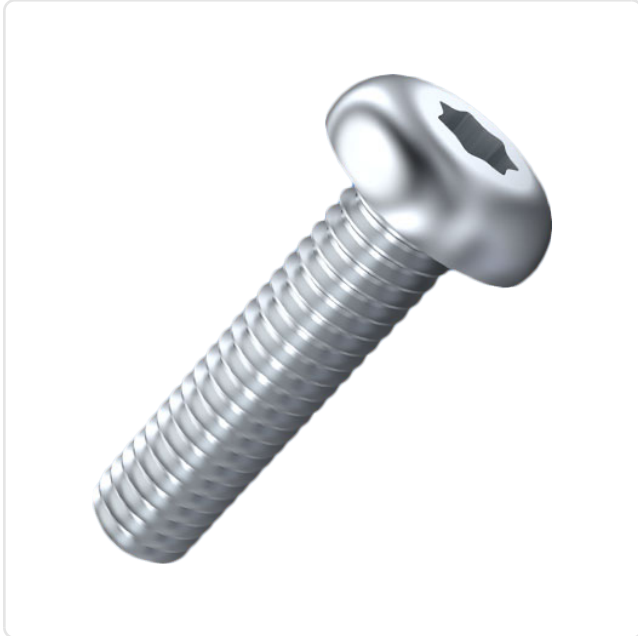
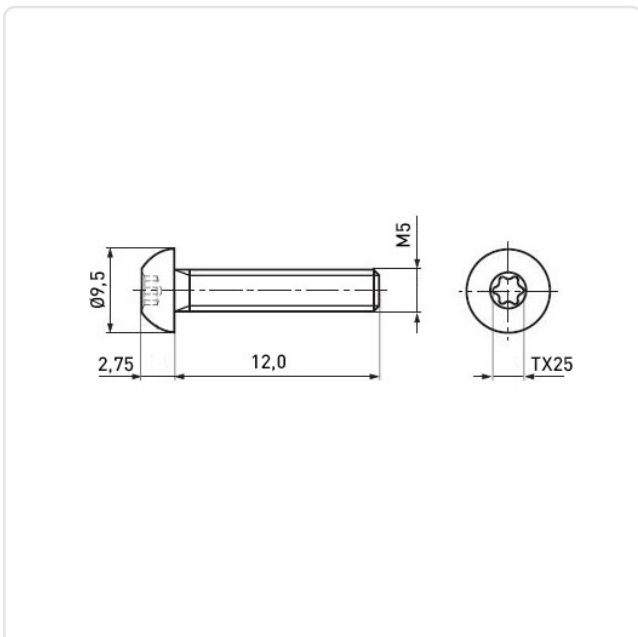

Image may be similar

Actuator Size:	Torx T25
DIN/ISO:	ISO7380-1
Drive Type:	TORX
Finish:	Plain
Head Diameter [mm]:	9.5
Head Height [mm]:	2.75
Head Shape:	Button Head
Length [mm]:	12
Material:	Stainless Steel AISI 304 / A2
Material Group:	Stahl rostfrei
Thread Size:	M5
Weight:	2.26g
Conformities:	



You can find all information on the web on our article detail page

[Button Head Screw ISO7380-1 M5x12
Stainless Steel A2 Hexalobular](#)

Would you like individual advice?

We look forward to your email to products@ettinger.de.

Subject to change and errors.