

Article datasheet

## Socket Head Screw ISO14580 M2.5x4 Stainless Steel A2 Hexalobular

Article-No.: 001.63.202



Image may be similar

Actuator Size:	Torx T8
DIN/ISO:	ISO14580
Drive Type:	TORX
Finish:	Plain
Head Diameter [mm]:	4.5
Head Height [mm]:	1.85
Head Shape:	Flat Cheese Head
Length [mm]:	4
Material:	Stainless Steel AISI 304 / A2
Material Group:	Stahl rostfrei
Thread Size:	M2.5
Weight:	0.31g
Conformities:	

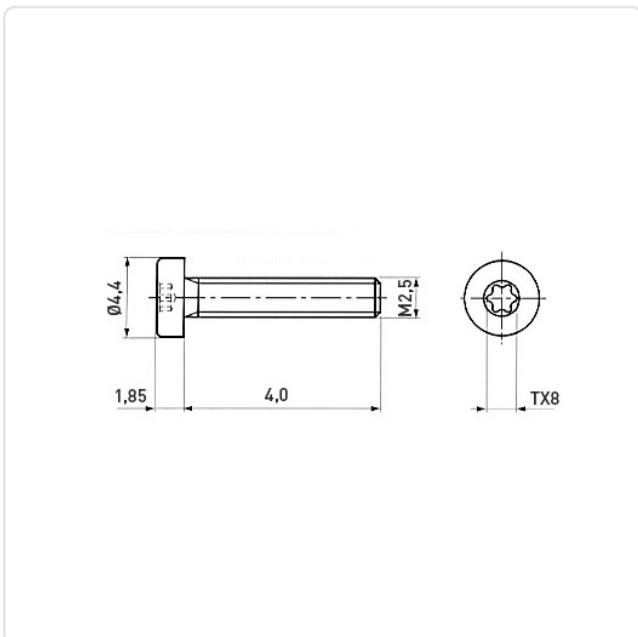

You can find all information on the web on our article detail page

[Socket Head Screw ISO14580 M2.5x4  
Stainless Steel A2 Hexalobular](#)

Would you like individual advice?

We look forward to your email to [products@ettinger.de](mailto:products@ettinger.de).

Subject to change and errors.