

Article datasheet

## Countersunk Screw ISO7046 M3x6 Black Galv. Steel 4.8 Cross Recessed

Article-No.: 001.12.320



Image may be similar

Actuator Size:	Phillips PH1
DIN/ISO:	ISO7046
Drive Type:	Cross Recess / Phillips-H
Finish:	Galvanized, Black, 5 µm, A2R
Head Diameter [mm]:	5.6
Head Height [mm]:	1.65
Head Shape:	Countersunk Head
Length [mm]:	6
Material:	Steel 4.8
Material Group:	Stahl
Thread Size:	M3
Weight:	0.36g
Conformities:	

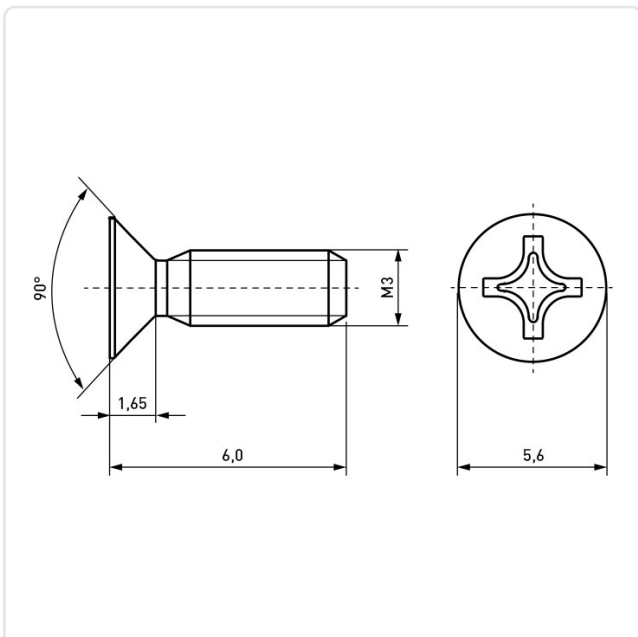

You can find all information on the web on our article detail page

[Countersunk Screw ISO7046 M3x6 Black Galv. Steel 4.8 Cross Recessed](#)

Would you like individual advice?

We look forward to your email to [products@ettinger.de](mailto:products@ettinger.de).

Subject to change and errors.