

Article datasheet

Pan Head Screw ISO14583 M5x12 Steel 4.8 Zinc Plated Hexalobular

Article-No.: 001.51.551

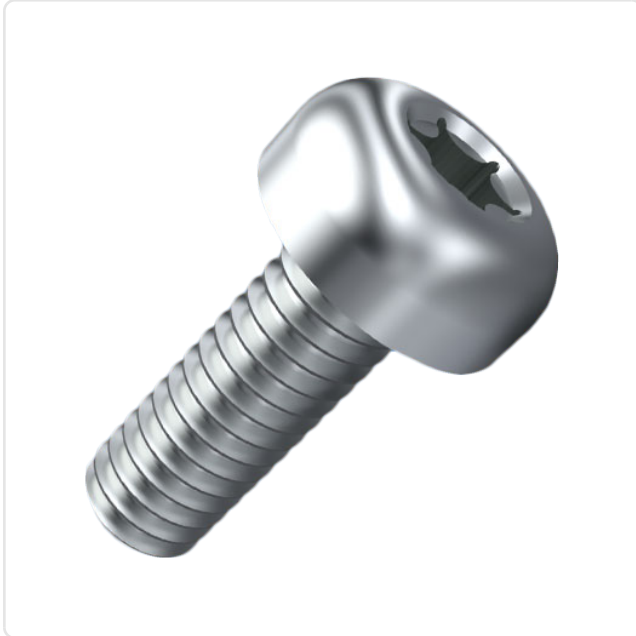
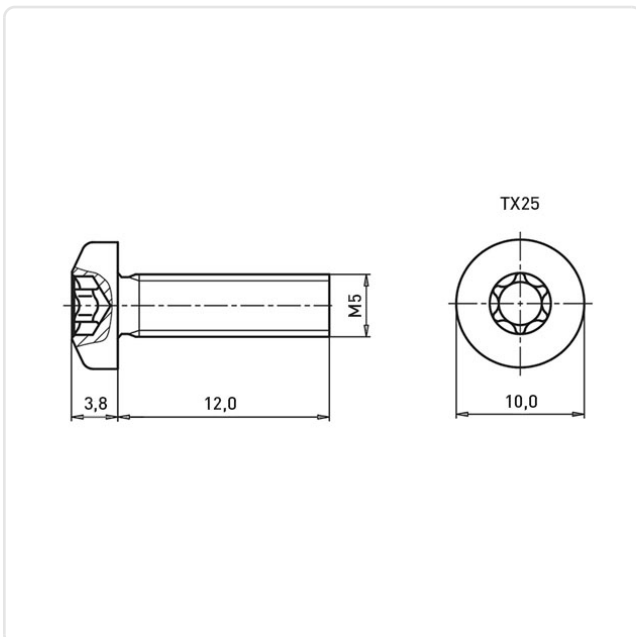

Image may be similar

Actuator Size:	Torx T25
DIN/ISO:	ISO7045
Drive Type:	TORX
Finish:	Galvanized, Blue, 5 µm, A2K
Head Diameter [mm]:	10
Head Height [mm]:	3.8
Head Shape:	Pan Head
Length [mm]:	12
Material:	Steel 4.8
Material Group:	Stahl
Thread Size:	M5
Weight:	3.07g
Conformities:	



You can find all information on the web on our article detail page

[Pan Head Screw ISO14583 M5x12 Steel 4.8 Zinc Plated Hexalobular](#)

Would you like individual advice?

We look forward to your email to products@ettinger.de.

Subject to change and errors.