

Article datasheet

Blade Terminal 6.3x0.8 | 45° | ø5.3 Tin-Plated Brass

Article-No.: 019.68.351



Image may be similar

Bending Angle [°]:	45
Finish:	Tin-Plated
Material:	Brass lead-free
Mounting Hole [mm]:	5.3
Plug-In Length [mm]:	8
Size [mm]:	6.3x0.8
Tabs:	1
Weight:	0.74g
Conformities:	



You can find all information on the web on our article detail page

[Blade Terminal 6.3x0.8 | 45° | ø5.3 Tin-Plated Brass](#)

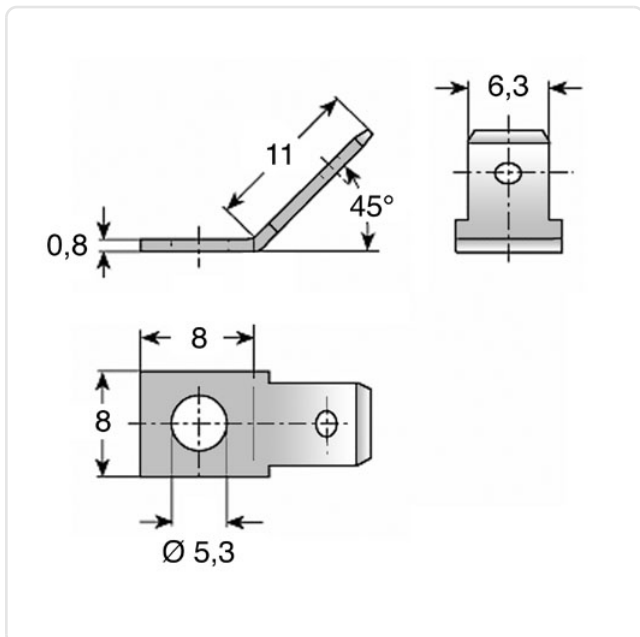

Would you like individual advice?

We look forward to your email to products@ettinger.de.

Subject to change and errors.