

Article datasheet

Self-Clinching Stud M3x6.0 A2 Stainless Steel Passivated

Article-No.: 004.62.329



Image may be similar

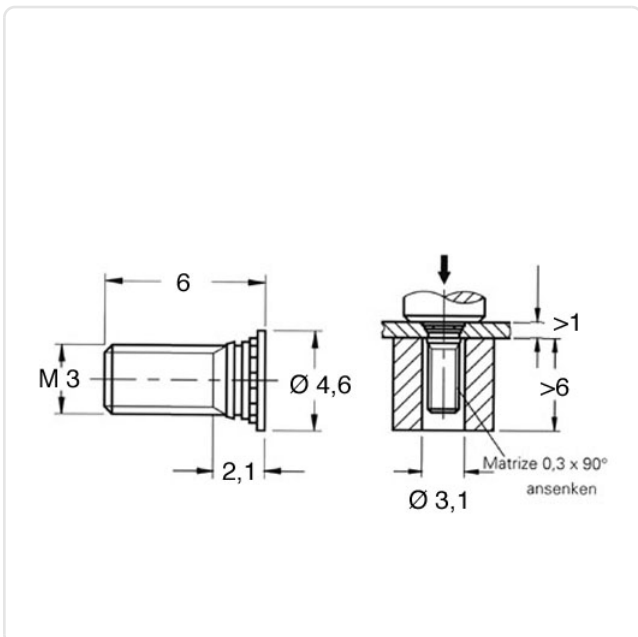

Area of Application:	For Metallic Materials
Finish:	Passivated, Clear
Head Diameter [mm]:	4.6
Length [mm]:	6
Material:	Stainless Steel AISI 304 / A2
Material Group:	Stainless Steel
Minimum Edge Distance [mm]:	5.6
Panel Hole Ø [mm]:	3
Panel Thickness [mm]:	1
Thread Size:	M3
Weight:	0.31g
Conformities:	



You can find all information on the web on our article detail page

[Self-Clinching Stud M3x6.0 A2 Stainless Steel Passivated](#)

Would you like individual advice?

We look forward to your email to products@ettinger.de.

Subject to change and errors.