

Article datasheet

PCB Support 15.9 | ø3.2 | ø3.2 Polyamide 6.6 natural

Article-No.: 006.30.156



Image may be similar

Color: Natural
 Flammability Class: UL94-V2
 Length [mm]: 15.9
 Material: PA 6.6
 Material Group: Plastic
 PCB Hole Ø [mm]: 3.2
 PCB Thickness [mm]: 1.6
 Panel Hole Ø [mm]: 3.2
 Panel Thickness [mm]: 1.6
 Weight: 0.33g
 Conformities:



You can find all information on the web on our article detail page

[PCB Support 15.9 | ø3.2 | ø3.2 Polyamide 6.6 natural](#)

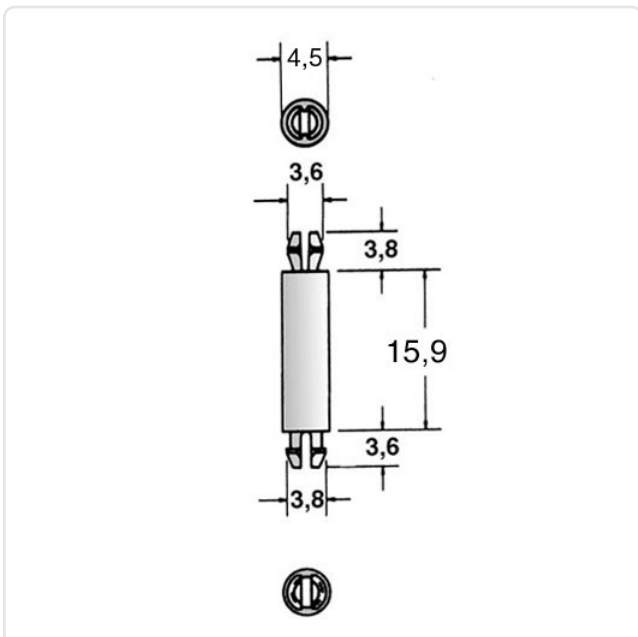

Would you like individual advice?

We look forward to your email to products@ettinger.de.

Subject to change and errors.