

Article datasheet

Long Nut M24 DIN6334 A2 Stainless Steel AF 36x72 / M24

Article-No.: 002.20.242

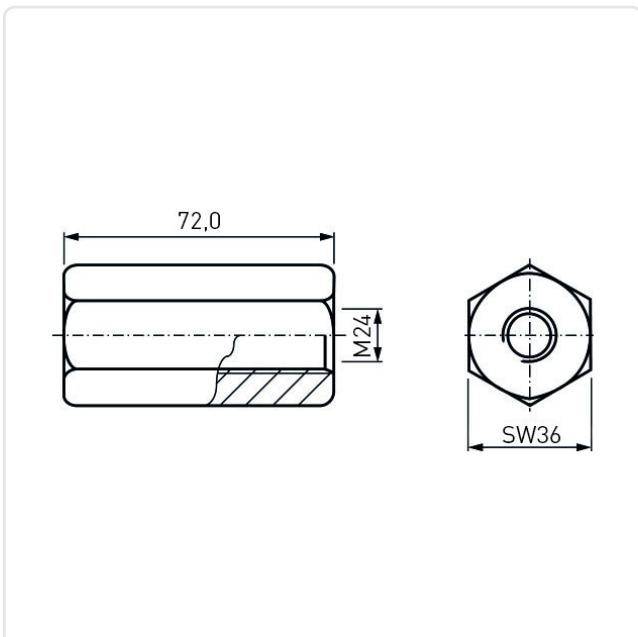

Image may be similar

DIN/ISO: DIN6334
Finish: Plain
Length [mm]: 72
Material: Stainless Steel AISI 304 / A2
Material Group: Stainless Steel
Profile: Hexagonal
Thread Size: M24
Conformities:



You can find all
information on the web on
our article detail page



Would you like individual advice?

We look forward to your email to products@ettinger.de.

Subject to change and errors.