

Article datasheet

Insulated Standoff PA-Brass M/F AF8x20 | F=M4x6 M=M4x8

Article-No.: 005.58.420



Image may be similar

AF / OD [mm]:	8
Female Thread Length [mm]:	6
Female Thread Size:	M4
Flammability Class:	UL94-V2
Length [mm]:	20
Male Thread Length [mm]:	8
Male Thread Size:	M4
Material:	PA 6.6
Material Group:	Plastic
Profile:	Hexagonal
Thread Insert Material:	Brass
Weight:	3.38g
Conformities:	

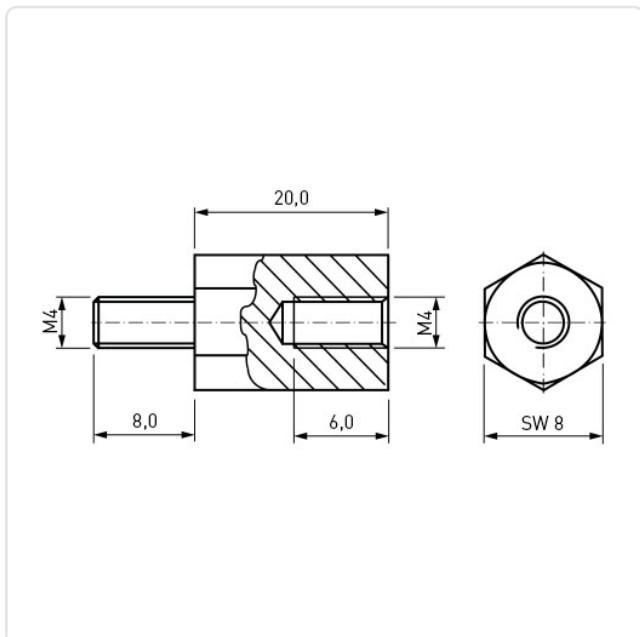

You can find all information on the web on our article detail page

[Insulated Standoff PA-Brass M/F AF8x20 | F=M4x6 M=M4x8](#)

Would you like individual advice?

We look forward to your email to products@ettinger.de.

Subject to change and errors.