

Article datasheet

SMD Test Point 3.8x2.8 Phosphor Bronze Silver-Plated | 1000 pcs On Reel

Article-No.: 012.18.855

Manufacturer: Keystone Electronics

Manufacturer article-no.: 5016

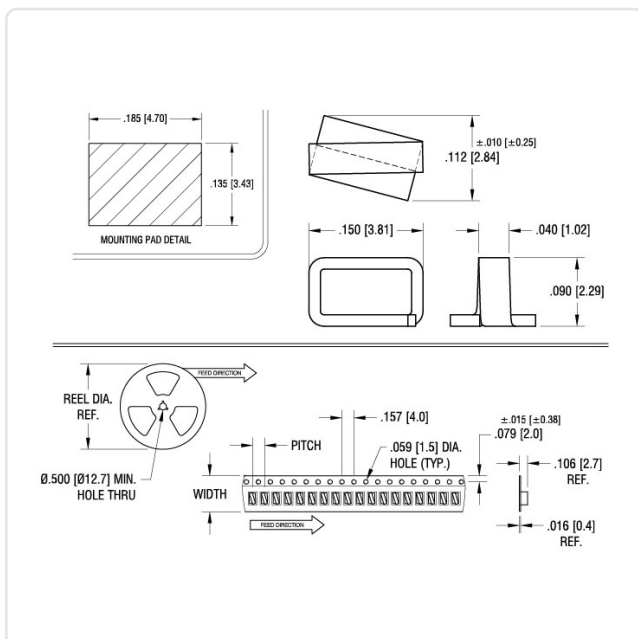

Image may be similar

Finish: Silver-Plated
 Height [mm]: 2.3
 Length [mm]: 3.8
 Material: Phosphor Bronze
 Material Group: Phosphor Bronze
 Width [mm]: 2.8
 Weight: 11g
 Conformities:



You can find all information on the web on our article detail page
[SMD Test Point 3.8x2.8 Phosphor Bronze Silver-Plated | 1000 pcs On Reel](#)



Would you like individual advice?

We look forward to your email to products@ettinger.de.

Subject to change and errors.