

Article datasheet

Hexagon Head Screw ISO4017 M4x10 Steel 8.8 Zinc Plated

Article-No.: 001.13.441



Image may be similar

Actuator Size:	Hexagon Hex7
DIN/ISO:	ISO4017
Drive Type:	Hexagon
Finish:	Galvanized, Blue, 5 µm, A2K
Head Diameter [mm]:	7
Head Height [mm]:	2.8
Head Shape:	Hexagon Head
Length [mm]:	10
Material:	Steel 8.8, lead-free
Material Group:	Steel
Thread Size:	M4
Weight:	1.58g
Conformities:	

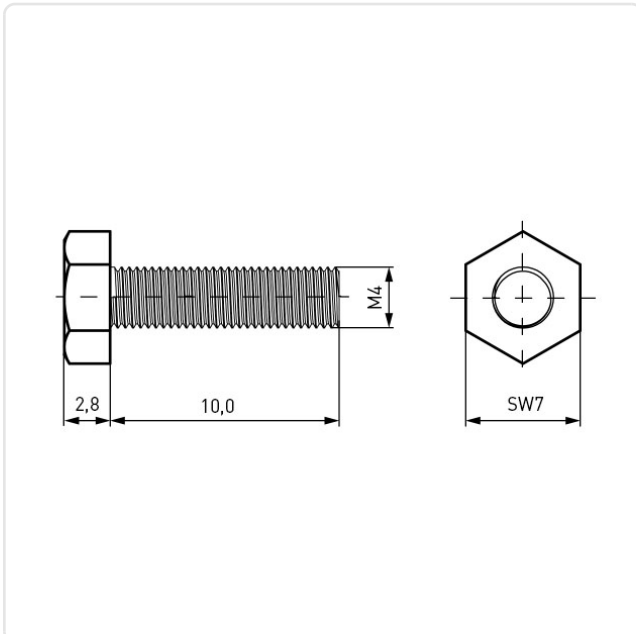

You can find all information on the web on our article detail page

[Hexagon Head Screw ISO4017 M4x10 Steel 8.8 Zinc Plated](#)

Would you like individual advice?

We look forward to your email to products@ettinger.de.

Subject to change and errors.