

Article datasheet

Pan Head Screw ISO14583 M4x12 Steel 4.8 Zinc Plated Hexalobular

Article-No.: 001.51.451

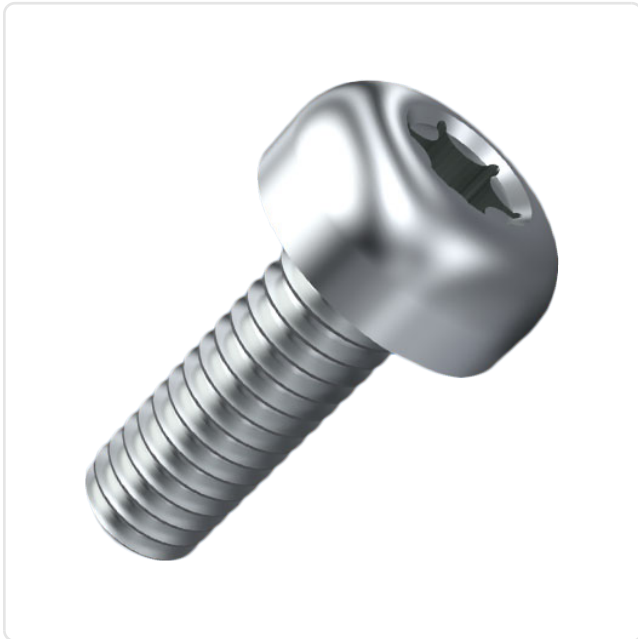
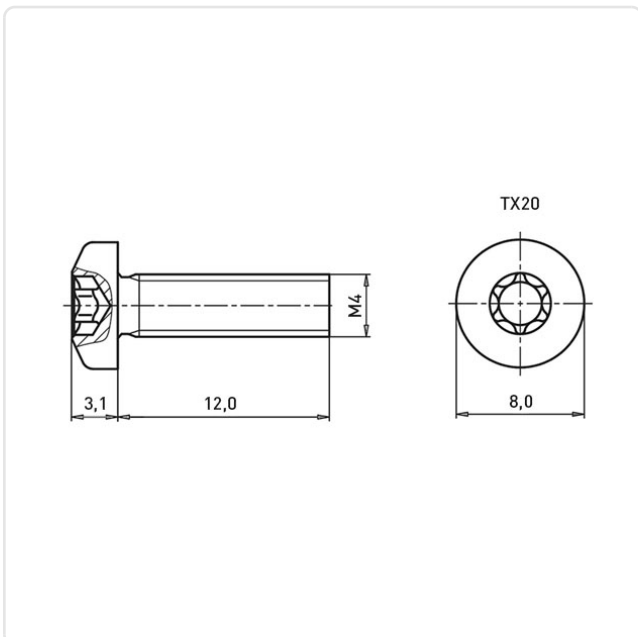

Image may be similar

Actuator Size:	Torx T20
DIN/ISO:	ISO14583
Drive Type:	TORX
Finish:	Galvanized, Blue, 5 µm, A2K
Head Diameter [mm]:	8
Head Height [mm]:	3.1
Head Shape:	Pan Head
Length [mm]:	12
Material:	Steel 4.8
Material Group:	Stahl
Thread Size:	M4
Weight:	1.75g
Conformities:	



You can find all information on the web on our article detail page

[Pan Head Screw ISO14583 M4x12 Steel 4.8 Zinc Plated Hexalobular](#)

Would you like individual advice?

We look forward to your email to products@ettinger.de.

Subject to change and errors.