

Article datasheet

Fan Guards Wire Form 1/4" Ring Spacing

Article-No.: 059.62.126

Manufacturer: Qualtek

Manufacturer article-no.: 08149

Qualtek



Image may be similar

Finish: Chrome-Plated

Lüftergröße [mm]: 40

Material: Steel

Material Group: Stahl

Model: Fan Guard

Weight: 4.79g

Conformities:



You can find all information on the web on our article detail page

[Fan Guards Wire Form 1/4" Ring Spacing](#)

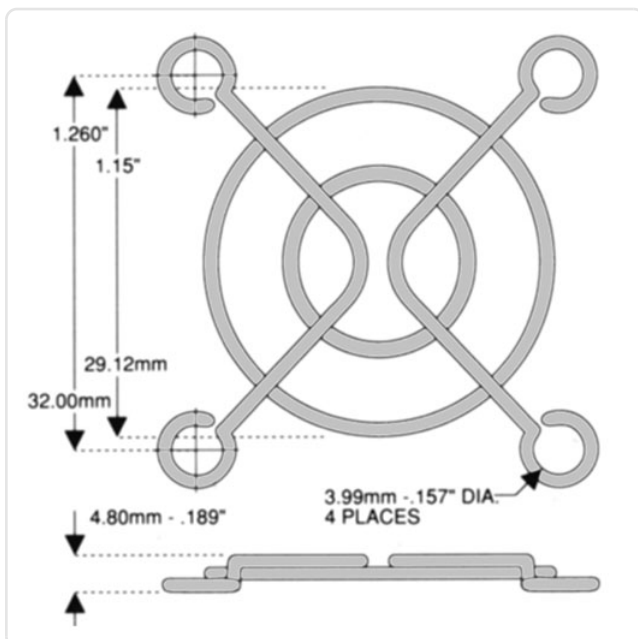

Would you like individual advice?

We look forward to your email to products@ettinger.de.

Subject to change and errors.