

Article datasheet

Pan Head Screw ISO1580 M8x60 Polyamide 6.6 Natural Slotted

Article-No.: 001.45.7080



Image may be similar

| | |
|---------------------|----------|
| Color: | Natural |
| DIN/ISO: | ISO1580 |
| Drive Type: | Slotted |
| Head Diameter [mm]: | 16 |
| Head Height [mm]: | 4.8 |
| Head Shape: | Pan Head |
| Length [mm]: | 60 |
| Material: | PA 6.6 |
| Material Group: | Plastic |
| Thread Size: | M8 |
| Weight: | 3.46g |
| Conformities: | |



You can find all information on the web on our article detail page

[Pan Head Screw ISO1580 M8x60 Polyamide 6.6 Natural Slotted](#)

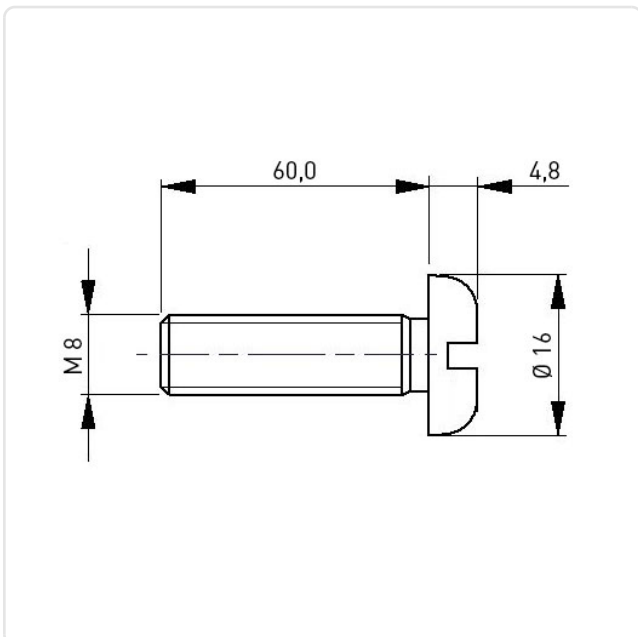

Would you like individual advice?

We look forward to your email to products@ettinger.de.

Subject to change and errors.