

Article datasheet

Countersunk Screw ISO7046 M2.5x5 A2 Plain Stainless Steel Cross Recessed

Article-No.: 001.12.218

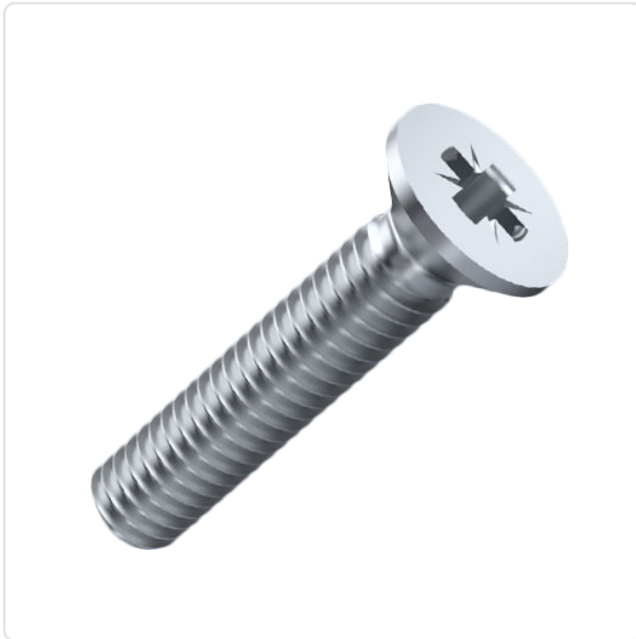
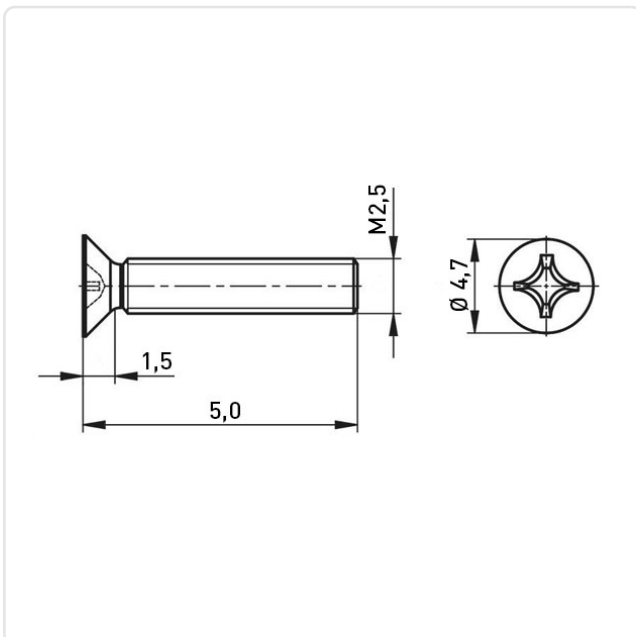

Image may be similar

Actuator Size:	Pozidriv PZ1
DIN/ISO:	ISO7046
Drive Type:	Cross Recess / Pozidriv-Z
Finish:	Plain
Head Diameter [mm]:	4.7
Head Height [mm]:	1.5
Head Shape:	Countersunk Head
Length [mm]:	5
Material:	Stainless Steel AISI 304 / A2
Material Group:	Stahl rostfrei
Thread Size:	M2.5
Weight:	0.19g
Conformities:	



You can find all information on the web on our article detail page

[Countersunk Screw ISO7046 M2.5x5 A2 Plain Stainless Steel Cross Recessed](#)

Would you like individual advice?

We look forward to your email to products@ettinger.de.

Subject to change and errors.