

Article datasheet

Countersunk Screw ISO7046 M3x14 A2 Plain Stainless Steel Cross Recessed

Article-No.: 001.12.352



Image may be similar

Actuator Size:	Phillips PH1
DIN/ISO:	ISO7046
Drive Type:	Cross Recess / Phillips-H
Finish:	Plain
Head Diameter [mm]:	5.6
Head Height [mm]:	1.65
Head Shape:	Countersunk Head
Length [mm]:	14
Material:	Stainless Steel AISI 304 / A2
Material Group:	Stahl rostfrei
Thread Size:	M3
Weight:	0.72g
Conformities:	

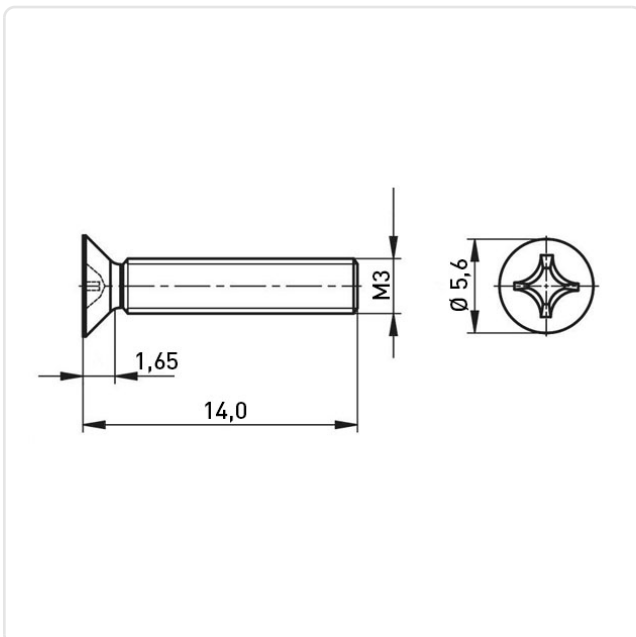

You can find all information on the web on our article detail page

[Countersunk Screw ISO7046 M3x14 A2 Plain Stainless Steel Cross Recessed](#)

Would you like individual advice?

We look forward to your email to products@ettinger.de.

Subject to change and errors.