

Article datasheet

Pan Head Screw ISO7045 M4x8 Steel 4.8 Nickel Plated Cross Recessed

Article-No.: 001.17.433



Image may be similar

Actuator Size:	Phillips PH2
DIN/ISO:	ISO7045
Drive Type:	Cross Recess / Phillips-H
Finish:	Nickel-Plated, 3 µm, E1E
Head Diameter [mm]:	8
Head Height [mm]:	3.1
Head Shape:	Pan Head
Length [mm]:	8
Material:	Steel 4.8, lead-free
Material Group:	Steel
Thread Size:	M4
Weight:	1.44g
Conformities:	

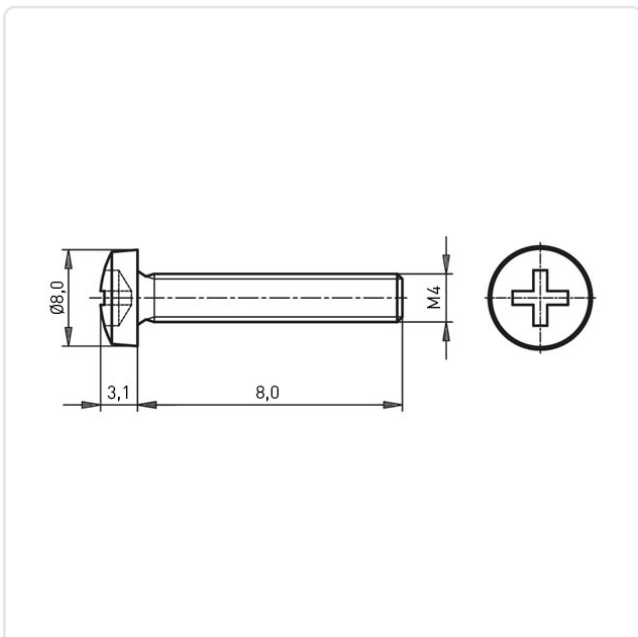

You can find all information on the web on our article detail page

[Pan Head Screw ISO7045 M4x8 Steel 4.8 Nickel Plated Cross Recessed](#)

Would you like individual advice?

We look forward to your email to products@ettinger.de.

Subject to change and errors.