

Article datasheet

Hexagon Serrated Flange Nut M4 DIN6923/ISO4161 A2 Plain Stainless Steel

Article-No.: 002.09.324

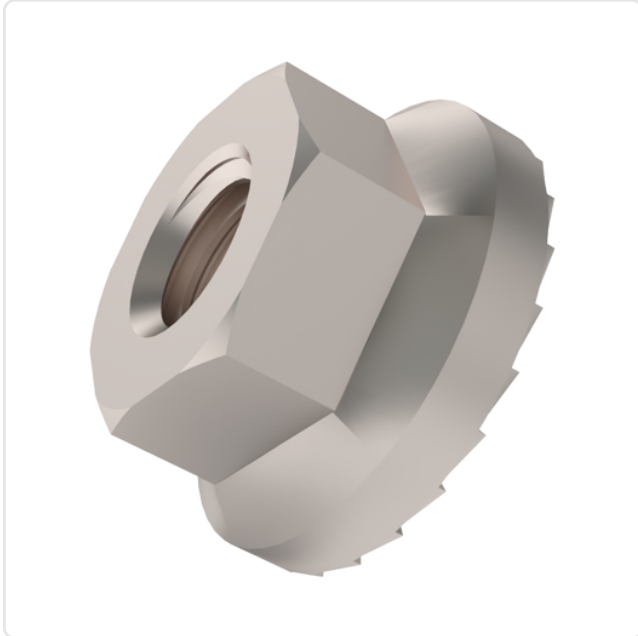

Image may be similar

AF / OD [mm]: 7
DIN/ISO: DIN6923 / ISO4161
Finish: Plain
Height [mm]: 4.6
Material: Stainless Steel AISI 304 / A2
Material Group: Stahl rostfrei
Thread Size: M4
Weight: 1.17g
Conformities:



You can find all information on the web on our article detail page

[Hexagon Serrated Flange Nut M4
DIN6923/ISO4161 A2 Plain Stainless Steel](#)

Would you like individual advice?

We look forward to your email to products@ettinger.de.

Subject to change and errors.

