

Article datasheet

Socket Head Screw ISO14580 M3x6 Stainless Steel A2 Hexalobular

Article-No.: 001.63.322



Image may be similar

Actuator Size:	Torx T10
DIN/ISO:	ISO14580
Drive Type:	TORX
Finish:	Plain
Head Diameter [mm]:	5.5
Head Height [mm]:	2.4
Head Shape:	Flat Cheese Head
Length [mm]:	6
Material:	Stainless Steel AISI 304 / A2
Material Group:	Stahl rostfrei
Thread Size:	M3
Weight:	0.65g
Conformities:	

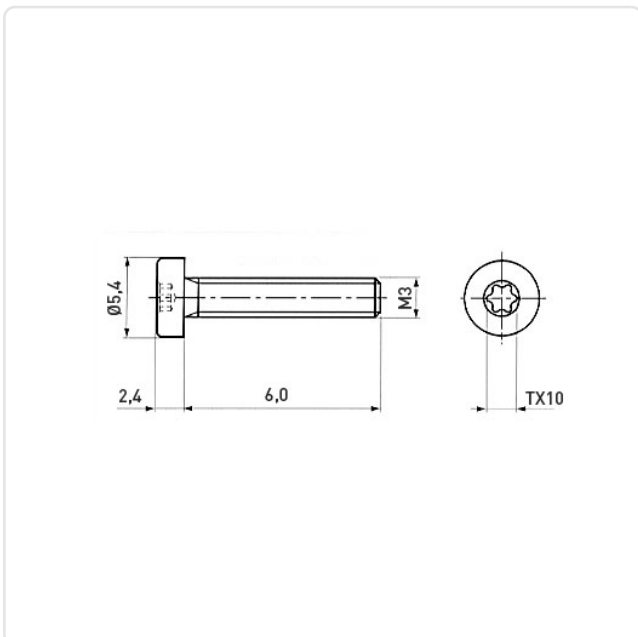

You can find all information on the web on our article detail page

[Socket Head Screw ISO14580 M3x6
Stainless Steel A2 Hexalobular](#)

Would you like individual advice?

We look forward to your email to products@ettinger.de.

Subject to change and errors.