

Article datasheet

Flanged Bearing $\varnothing 10/13/18 \times 15$ -2mm Polyamid 6.6 natural UL94-V2

Article-No.: 005.99.106

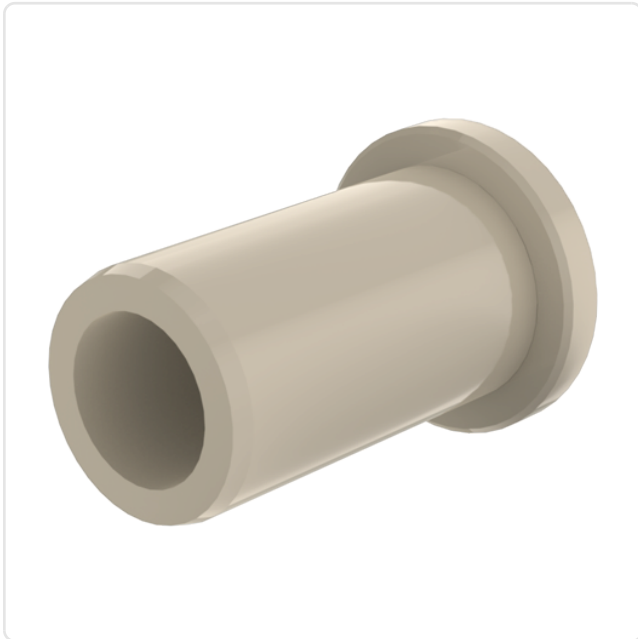

Image may be similar

| | |
|----------------------|--|
| Color: | Natural |
| Flammability Class: | UL94-V2 |
| Inner Diameter [mm]: | 10 |
| Length [mm]: | 15 |
| Lug Diameter [mm]: | 13 |
| Material: | PA 6.6 |
| Material Group: | Plastic |
| Model: | With High Lug |
| Outer Diameter [mm]: | 18 |
| Weight: | 1.22g |
| Conformities: | <div style="display: flex; gap: 10px;"> <div style="border: 1px solid black; padding: 2px; text-align: center;">SVHC COMPLIANT</div> <div style="border: 1px solid black; padding: 2px; text-align: center;">Reach COMPLIANT</div> <div style="border: 1px solid black; padding: 2px; text-align: center;">RoHS COMPLIANT</div> </div> |



You can find all information on the web on our article detail page

[Flanged Bearing \$\varnothing 10/13/18 \times 15\$ -2mm Polyamid 6.6 natural UL94-V2](#)

Would you like individual advice?

We look forward to your email to products@ettinger.de.

Subject to change and errors.

