

Article datasheet

Rivet Bush M2 | 0.5 - 0.6 Galvanized Steel

Article-No.: 002.15.012

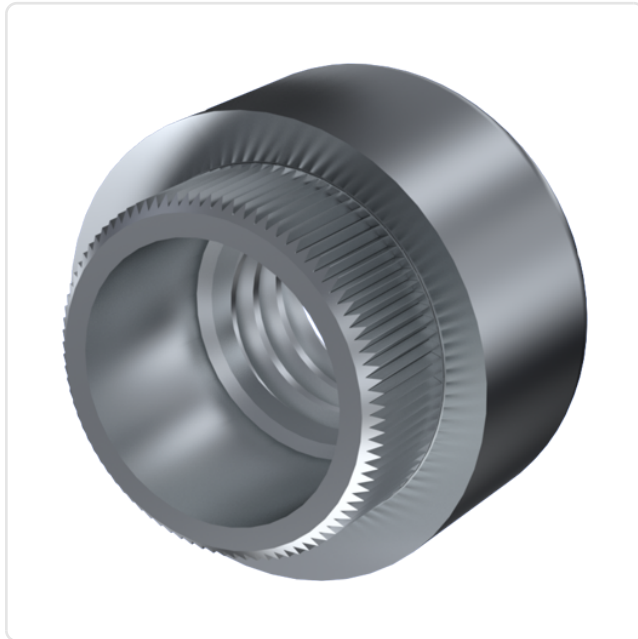

Image may be similar

| | |
|-----------------------|--|
| Finish: | Galvanized, Blue, 5 µm, A2K |
| Height [mm]: | 2.3 |
| Material: | Steel |
| Material Group: | Steel |
| Outer Diameter [mm]: | 5 |
| Panel Hole Ø [mm]: | 3.5 |
| Panel Thickness [mm]: | 0,5 - 0,6 |
| Thread Size: | M2 |
| Weight: | 0.32g |
| Conformities: | <div style="display: flex; gap: 10px;"> <div style="border: 1px solid black; padding: 2px; text-align: center;">Reach COMPLIANT ✓</div> <div style="border: 1px solid black; padding: 2px; text-align: center;">RoHS COMPLIANT ✓</div> <div style="border: 1px solid black; padding: 2px; text-align: center;">SVHC NOT COMPLIANT ✗</div> </div> |



You can find all information on the web on our article detail page

[Rivet Bush M2 | 0.5 - 0.6 Galvanized Steel](#)

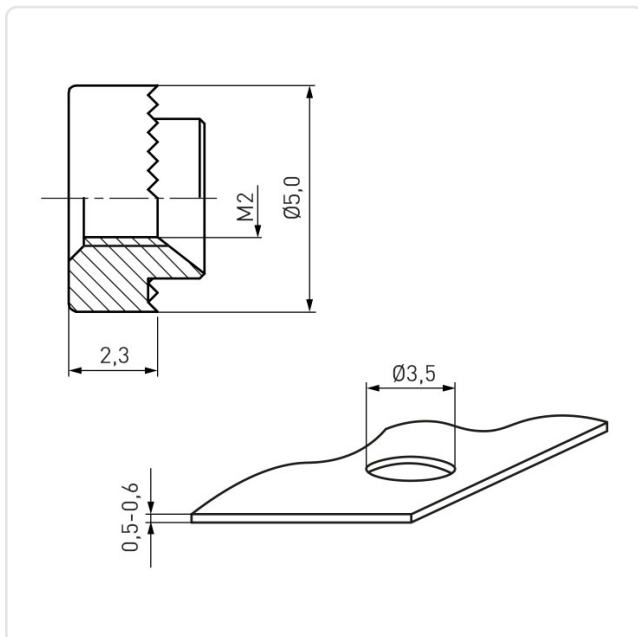

Would you like individual advice?

We look forward to your email to products@ettinger.de.

Subject to change and errors.