

Article datasheet

Thread Forming Screw DIN7500M M4x12 Galv. Steel Case Hardened Pozi CSK

Article-No.: 001.35.451



Image may be similar

Actuator Size:	Pozidriv PZ2
DIN/ISO:	DIN7500-M
Drive Type:	Cross Recess / Pozidriv-Z
Finish:	Galvanized, Blue, 5 µm, A2K
Head Diameter [mm]:	7.5
Head Height [mm]:	2.2
Head Shape:	Countersunk Head
Length [mm]:	12
Material:	Case-Hardened Steel
Material Group:	Steel
Thread Size:	M4
Thread Type:	Metric
Weight:	1.04g
Conformities:	

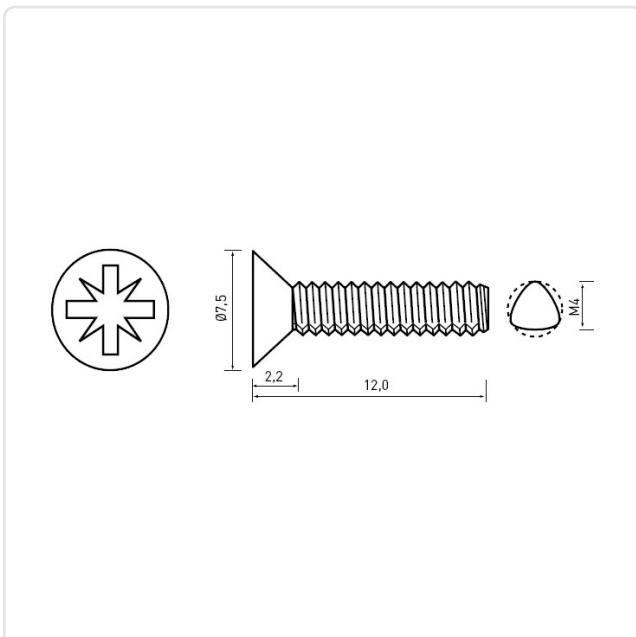

You can find all information on the web on our article detail page

[Thread Forming Screw DIN7500M M4x12 Galv. Steel Case Hardened Pozi CSK](#)

Would you like individual advice?

We look forward to your email to products@ettinger.de.

Subject to change and errors.