

Article datasheet

Standoff Plain Stainless Steel M/F AF4.75x4.8 F=4-40x3.1 M=4-40x6.4 w/o UC

Article-No.: 009.44.649



Image may be similar

AF / OD [mm]:	4.75
Female Thread Length [mm]:	3.1
Female Thread Size:	UNC4-40
Finish:	Plain
Length [mm]:	4.8
Male Thread Length [mm]:	6.4
Male Thread Size:	UNC4-40
Material:	Stainless Steel AISI 303 / X8CrNiS18-9
Material Group:	Stahl rostfrei
Profile:	Hexagonal
Undercut:	No
Weight:	0.77g
Conformities:	

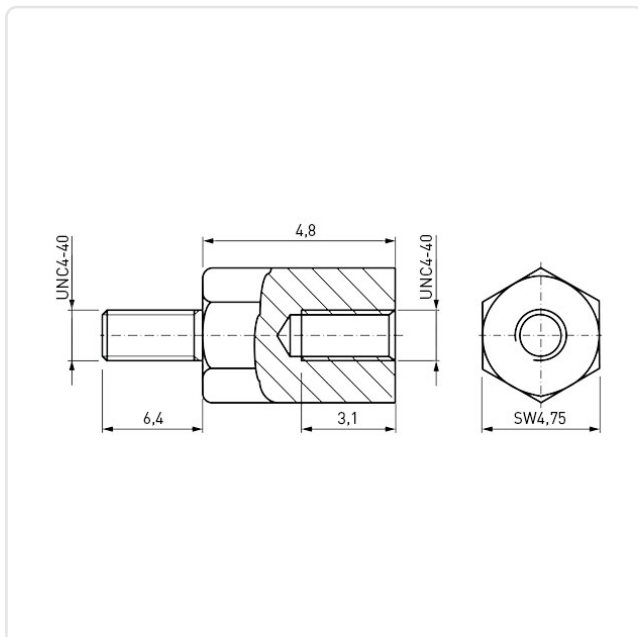

You can find all information on the web on our article detail page

[Standoff Plain Stainless Steel M/F AF4.75x4.8 F=4-40x3.1 M=4-40x6.4 w/o UC](#)

Would you like individual advice?

We look forward to your email to products@ettinger.de.

Subject to change and errors.