

Article datasheet

Countersunk Screw ISO7047 M2.5x6 Nickel-Plated Steel 4.8 Cross Recessed

Article-No.: 001.12.227

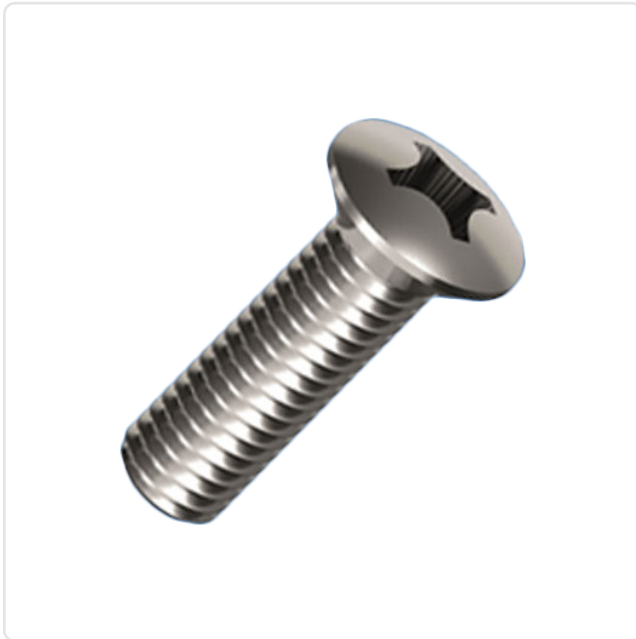
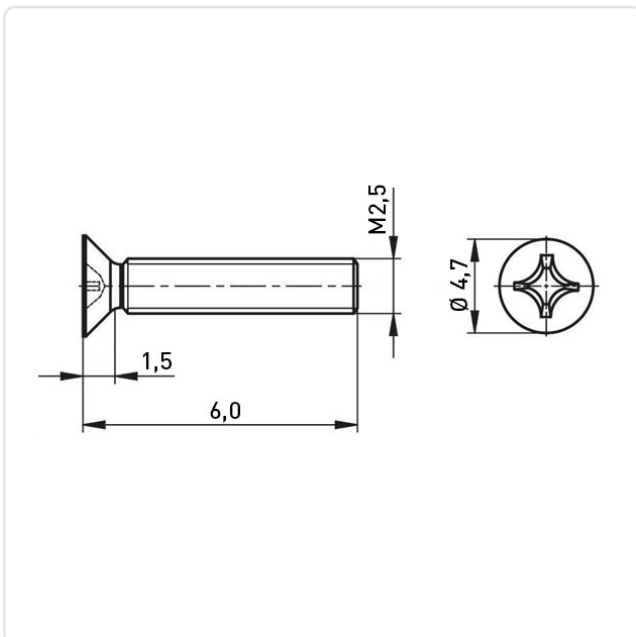

Image may be similar

Actuator Size:	Phillips PH1
DIN/ISO:	ISO7047
Drive Type:	Cross Recess / Phillips-H
Finish:	Nickel-Plated, 3 µm, E1E
Head Diameter [mm]:	4.7
Head Height [mm]:	1.5
Head Shape:	Countersunk Head
Length [mm]:	6
Material:	Steel 4.8
Material Group:	Stahl
Thread Size:	M2.5
Weight:	0.24g
Conformities:	



You can find all information on the web on our article detail page

[Countersunk Screw ISO7047 M2.5x6 Nickel-Plated Steel 4.8 Cross Recessed](#)

Would you like individual advice?

We look forward to your email to products@ettinger.de.

Subject to change and errors.