

Article datasheet

Thread Forming Screw DIN7500C M3x10 A2 Plain Stainless Steel Torx Pan Head

Article-No.: 001.31.349



Image may be similar

Actuator Size:	Torx T10
DIN/ISO:	DIN7500-C
Drive Type:	TORX
Finish:	Plain
Head Diameter [mm]:	6
Head Height [mm]:	2.4
Head Shape:	Pan Head
Length [mm]:	10
Material:	Stainless Steel AISI 304 / A2
Material Group:	Stahl rostfrei
Thread Size:	M3
Thread Type:	Metric
Weight:	0.72g
Conformities:	

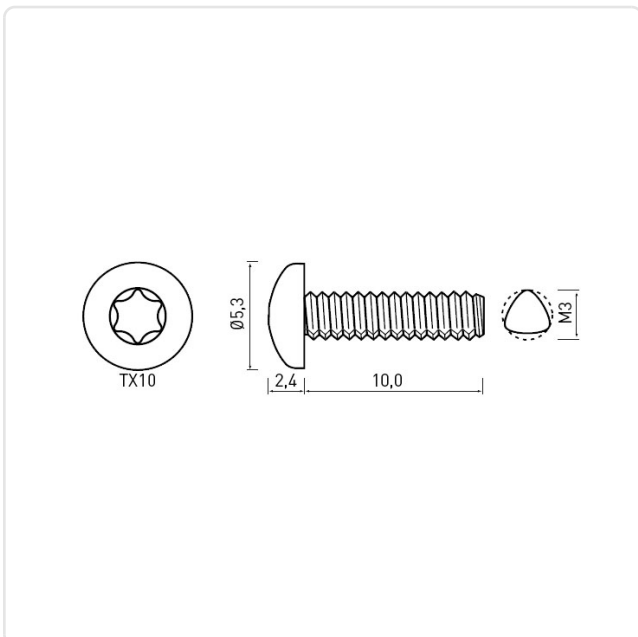

You can find all information on the web on our article detail page

[Thread Forming Screw DIN7500C M3x10 A2 Plain Stainless Steel Torx Pan Head](#)

Would you like individual advice?

We look forward to your email to products@ettinger.de.

Subject to change and errors.