

Article datasheet

Turret Terminal 1-pole M3 Ceramic C221 | Tinned Brass

Article-No.: 013.80.733

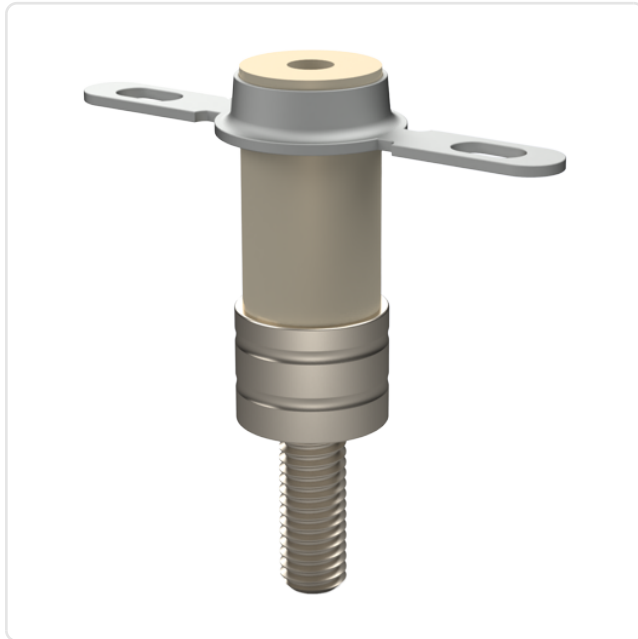

Image may be similar

Finish:	Tin-Plated
Insulation:	KERAMIK
Length [mm]:	24.7
Material:	Brass
Material Group:	Brass
Thread Length [mm]:	8
Thread Size:	M3
Weight:	2.84g
Conformities:	



You can find all information on the web on our article detail page

[Turret Terminal 1-pole M3 Ceramic C221 | Tinned Brass](#)

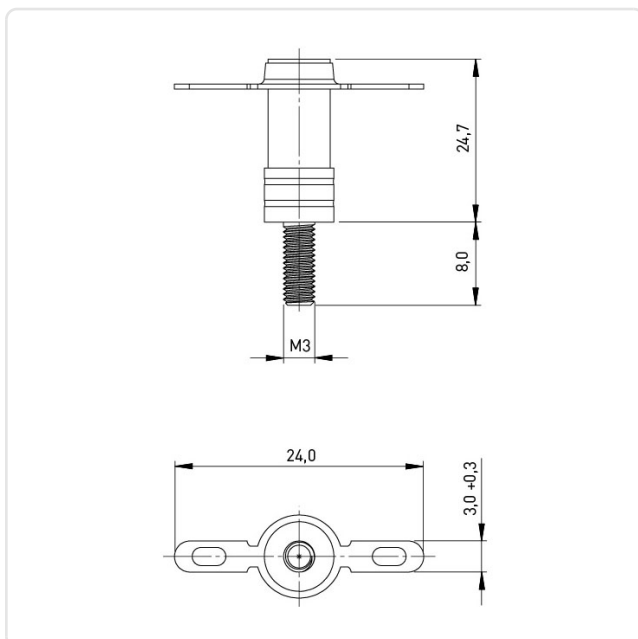

Would you like individual advice?

We look forward to your email to products@ettinger.de.

Subject to change and errors.