

Article datasheet

Hexagon Head Screw ISO4017 M6x8 Polyamide 6.6 Natural

Article-No.: 001.43.636



Image may be similar

Actuator Size:	Hexagon Hex10
Color:	Natural
DIN/ISO:	ISO4017
Drive Type:	Hexagon
Flammability Class:	UL94-V2
Head Diameter [mm]:	10
Head Height [mm]:	4
Head Shape:	Hexagon Head
Length [mm]:	8
Material:	PA 6.6
Material Group:	Plastic
Thread Size:	M6
Weight:	0.38g
Conformities:	

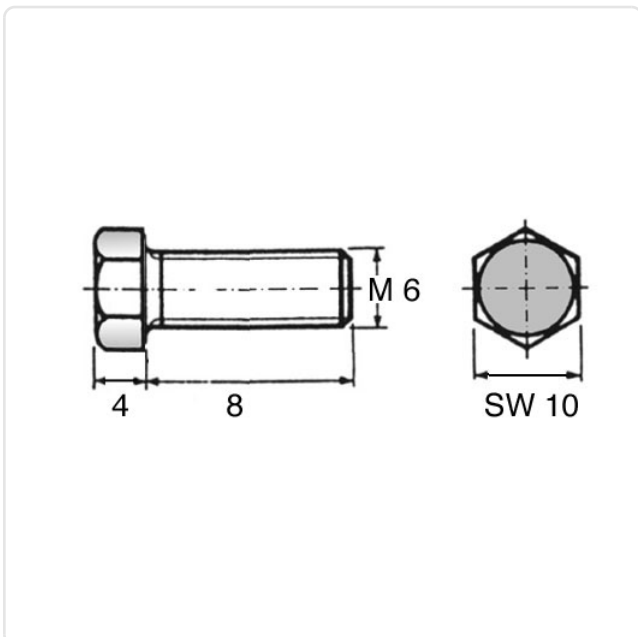

You can find all information on the web on our article detail page

[Hexagon Head Screw ISO4017 M6x8 Polyamide 6.6 Natural](#)

Would you like individual advice?

We look forward to your email to products@ettinger.de.

Subject to change and errors.