

Article datasheet

Hole Plug $\varnothing 7.2/11.0$ mm Polyethylene,natural/Not UL-listed

Article-No.: 014.10.071

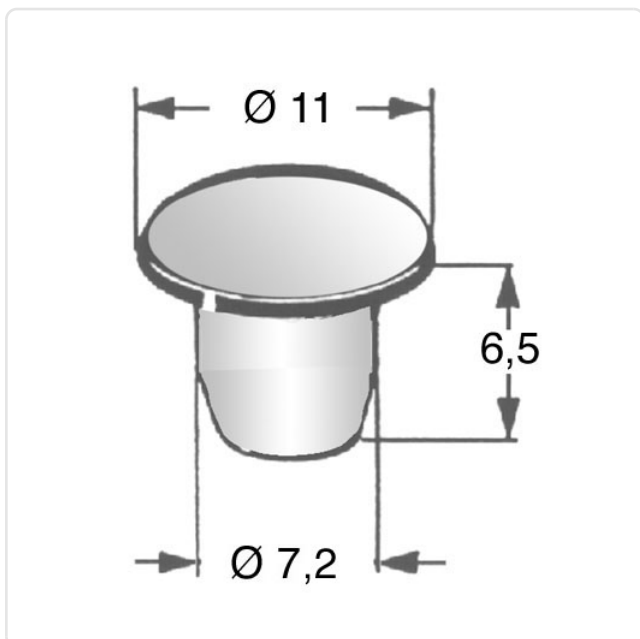

Image may be similar

Color: Natural
Inner Diameter [mm]: 7.2
Material: PE - Polyethylene
Material Group: Plastic
Model: Hole Plug
Outer Diameter [mm]: 11
Weight: 0.22g
Conformities:



You can find all information on the web on our article detail page
[Hole Plug \$\varnothing 7.2/11.0\$ mm Polyethylene,natural/Not UL-listed](#)



Would you like individual advice?

We look forward to your email to products@ettinger.de.

Subject to change and errors.