

Article datasheet

Cheese Head Screw ISO1207 M1.6x8 A2 Plain Stainless Steel Slotted

Article-No.: 001.14.032



Image may be similar

DIN/ISO:	ISO1207
Drive Type:	Slotted
Finish:	Plain
Head Diameter [mm]:	3
Head Height [mm]:	1
Head Shape:	Cheese Head
Length [mm]:	8
Material:	Stainless Steel AISI 304 / A2
Material Group:	Stahl rostfrei
Thread Size:	M1.6
Weight:	0.15g
Conformities:	



You can find all information on the web on our article detail page

[Cheese Head Screw ISO1207 M1.6x8 A2 Plain Stainless Steel Slotted](#)

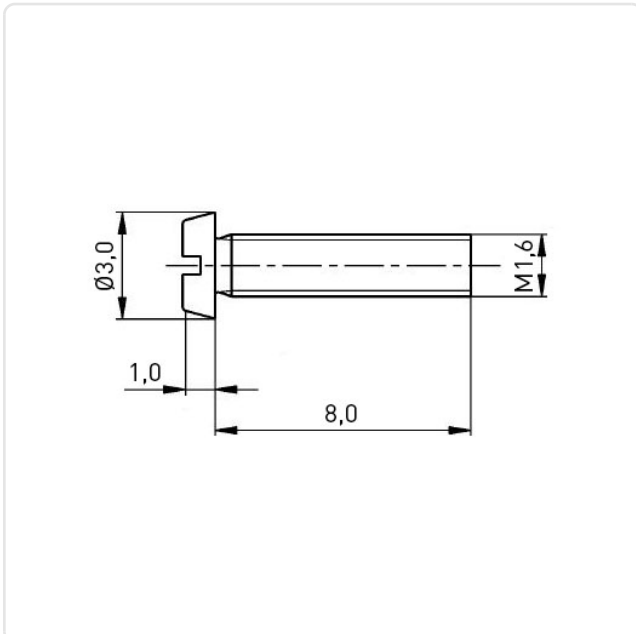

Would you like individual advice?

We look forward to your email to products@ettinger.de.

Subject to change and errors.