

Article datasheet

Standoff Plain Stainless Steel M/F AF7x12 F=M4x9 M=M4x8 w/ Undercut

Article-No.: 005.14.129



Image may be similar

AF / OD [mm]:	7
Female Thread Length [mm]:	9
Female Thread Size:	M4
Finish:	Plain
Length [mm]:	12
Male Thread Length [mm]:	8
Male Thread Size:	M4
Material:	Stainless Steel AISI 303 / X8CrNiS18-9
Material Group:	Stahl rostfrei
Profile:	Hexagonal
Undercut:	Yes
Weight:	3.7g
Conformities:	

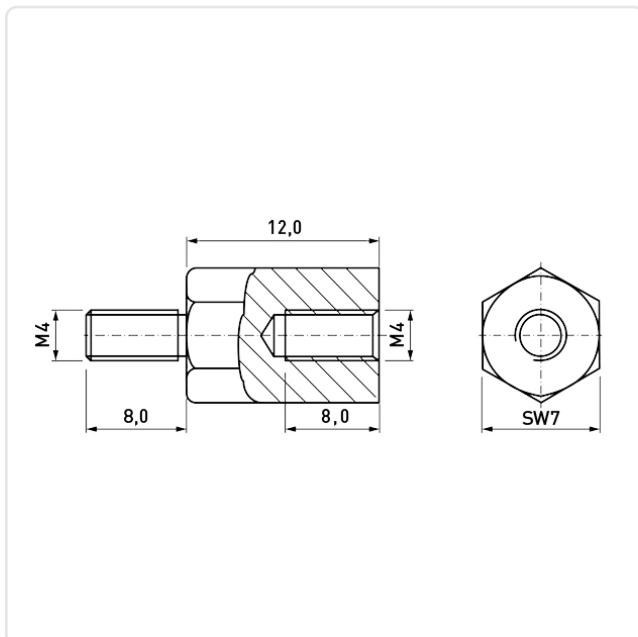

You can find all information on the web on our article detail page

[Standoff Plain Stainless Steel M/F AF7x12 F=M4x9 M=M4x8 w/ Undercut](#)

Would you like individual advice?

We look forward to your email to products@ettinger.de.

Subject to change and errors.