

Article datasheet

Set Screw DIN551/ISO4766 M5x6 PA-66 Natural Slotted Flat Point

Article-No.: 001.40.526



Image may be similar

Color:	Natural
DIN/ISO:	ISO4766
Drive Type:	Slotted
Flammability Class:	UL94-V2
Length [mm]:	6
Material:	PA 6.6
Material Group:	Plastic
Point Type:	Flat Point
Thread Size:	M5
Weight:	0.08g
Conformities:	



You can find all information on the web on our article detail page

[Set Screw DIN551/ISO4766 M5x6 PA-66 Natural Slotted Flat Point](#)

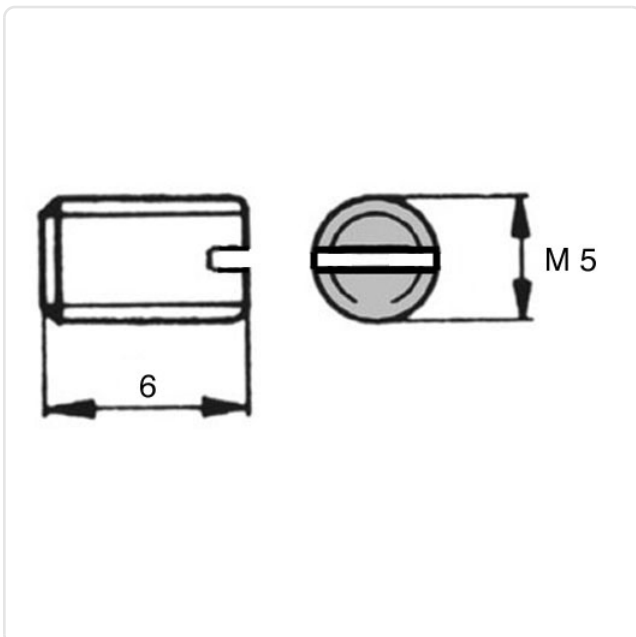

Would you like individual advice?

We look forward to your email to products@ettinger.de.

Subject to change and errors.