

Article datasheet

SEMS Screw ISO14583 TX/SLOT Z3 M4x6 Galvanized Steel 8.8 Spring Washer

Article-No.: 081.54.421

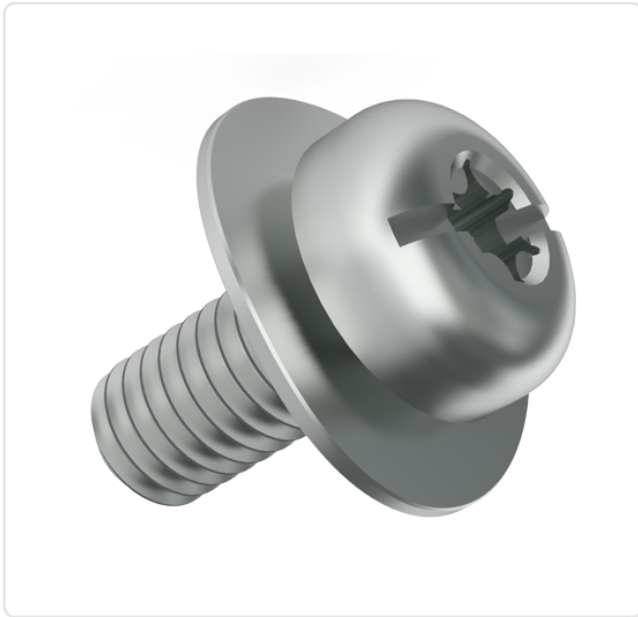
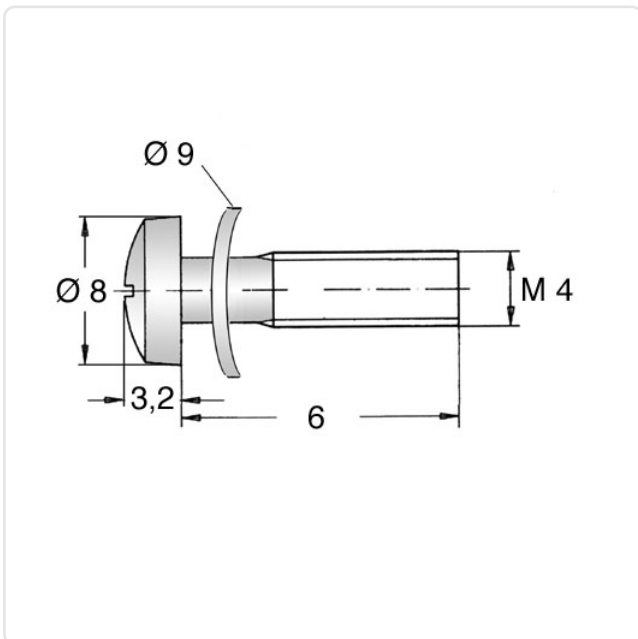

Image may be similar

Actuator Size:	Torx T20
Combination:	Spring Washer DIN6904
DIN/ISO:	ISO14583
Drive Type:	TORX / Slotted
Finish:	Galvanized, Blue, 5 µm, A2K
Head Diameter [mm]:	8
Head Height [mm]:	3.1
Head Shape:	Pan Head
Length [mm]:	6
Material:	Steel 8.8, lead-free
Material Group:	Steel
Thread Size:	M4
Weight:	1.59g
Conformities:	



You can find all information on the web on our article detail page

[SEMS Screw ISO14583 TX/SLOT Z3 M4x6 Galvanized Steel 8.8 Spring Washer](#)

Would you like individual advice?

We look forward to your email to products@ettinger.de.

Subject to change and errors.