

Article datasheet

Pan Head Screw ISO7045 M6x10 Stainless Steel A2 Cross Recessed

Article-No.: 001.17.642



Image may be similar

Actuator Size:	Phillips PH2
DIN/ISO:	ISO7045
Drive Type:	Cross Recess / Phillips-H
Finish:	Plain
Head Diameter [mm]:	12
Head Height [mm]:	4.6
Head Shape:	Pan Head
Length [mm]:	10
Material:	Stainless Steel AISI 304 / A2
Material Group:	Stainless Steel
Thread Size:	M6
Weight:	4.55g
Conformities:	

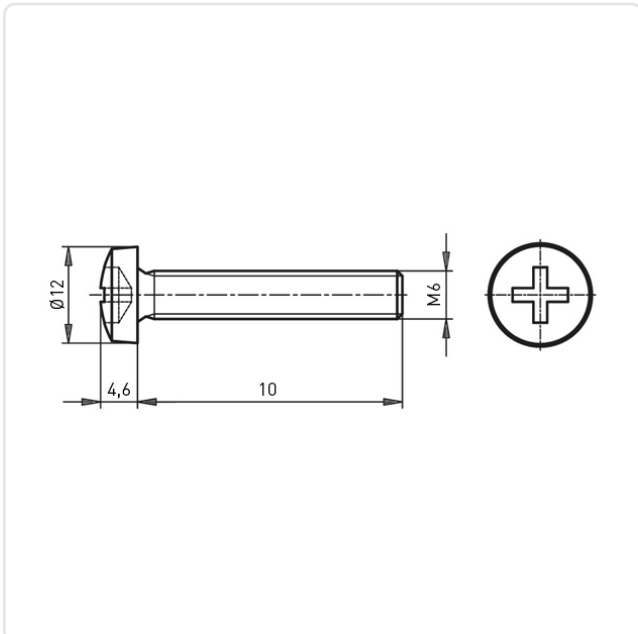

You can find all information on the web on our article detail page

[Pan Head Screw ISO7045 M6x10 Stainless Steel A2 Cross Recessed](#)

Would you like individual advice?

We look forward to your email to products@ettinger.de.

Subject to change and errors.