

Article datasheet

## Screw-On Bumper Ø20.0x10.0 PVC black

Article-No.: 017.54.201

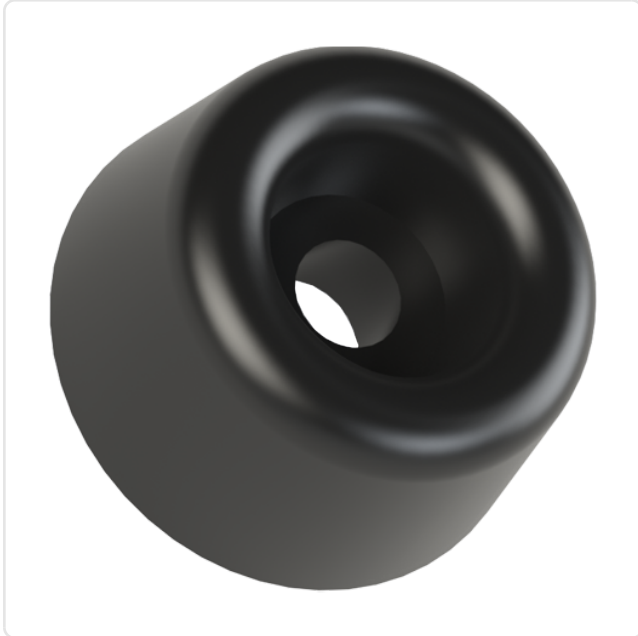

Image may be similar

Bumper Design:	Round, Tapered
Color:	Black
Diameter [mm]:	20
Height [mm]:	10
Material:	PVC - Polyvinyl Chloride
Material Group:	Plastic
Mounting Hole [mm]:	4.3
Weight:	2.49g
Conformities:	<div style="display: flex; gap: 10px;"> <div style="border: 1px solid black; padding: 2px; font-size: 8px;">SVHC COMPLIANT</div> <div style="border: 1px solid black; padding: 2px; font-size: 8px;">Reach COMPLIANT</div> <div style="border: 1px solid black; padding: 2px; font-size: 8px;">RoHS COMPLIANT</div> </div>



You can find all information on the web on our article detail page

[Screw-On Bumper Ø20.0x10.0 PVC black](#)

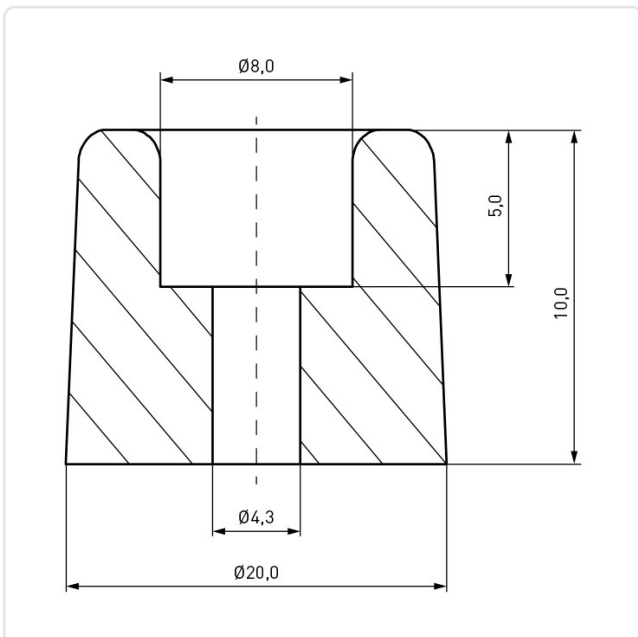

Would you like individual advice?

We look forward to your email to [products@ettinger.de](mailto:products@ettinger.de).

Subject to change and errors.