

Article datasheet

Pan Head Screw ISO14583 M3x18 Stainless Steel A2 Hexalobular

Article-No.: 082.56.322

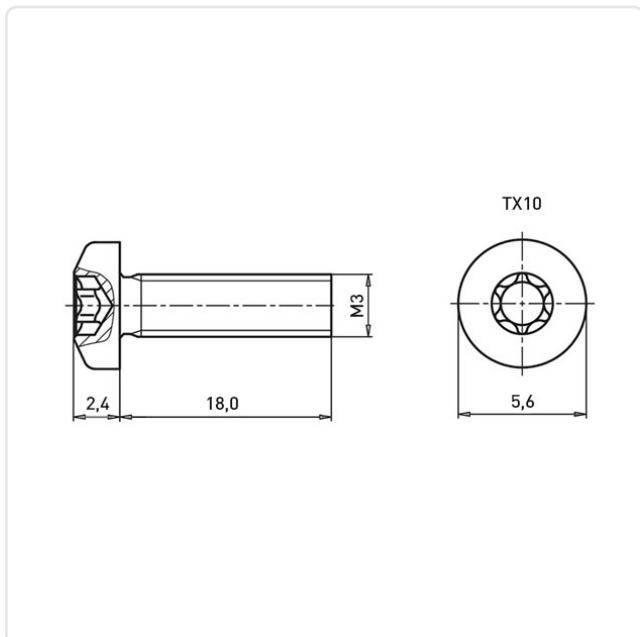

Image may be similar

Actuator Size:	Torx T10
DIN/ISO:	ISO14583
Drive Type:	TORX
Finish:	Plain
Head Diameter [mm]:	5.6
Head Height [mm]:	2.4
Head Shape:	Pan Head
Length [mm]:	18
Material:	Stainless Steel AISI 304 / A2
Material Group:	Stainless Steel
Thread Size:	M3
Weight:	1.08g
Conformities:	



You can find all information on the web on our article detail page
[Pan Head Screw ISO14583 M3x18 Stainless Steel A2 Hexalobular](#)



Would you like individual advice?
 We look forward to your email to products@ettinger.de.

Subject to change and errors.