

Article datasheet

Countersunk Screw ISO14581 M2x6 A4 Plain Stainless Steel Torx

Article-No.: 001.60.129



Image may be similar

Actuator Size:	Torx T6
DIN/ISO:	ISO14581
Drive Type:	TORX
Finish:	Plain
Head Diameter [mm]:	3.8
Head Height [mm]:	1.2
Head Shape:	Countersunk Head
Length [mm]:	6
Material:	Stainless Steel AISI 316 / A4
Material Group:	Stahl rostfrei
Thread Size:	M2
Weight:	0.16g
Conformities:	

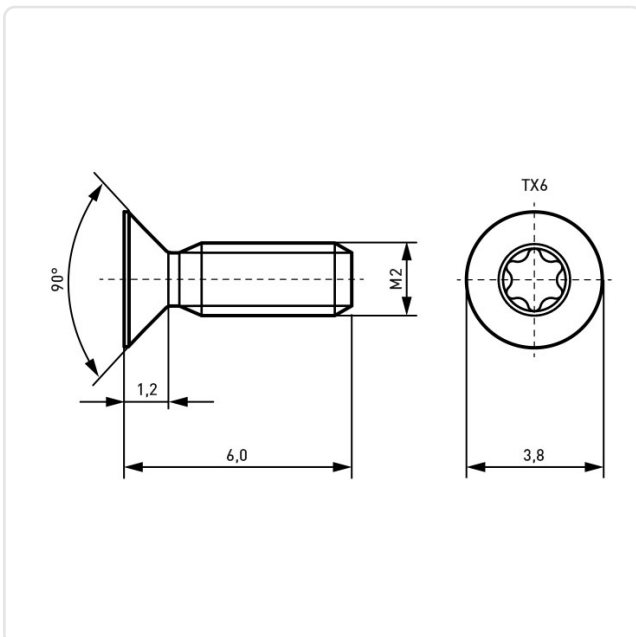

You can find all information on the web on our article detail page

[Countersunk Screw ISO14581 M2x6 A4 Plain Stainless Steel Torx](#)

Would you like individual advice?

We look forward to your email to products@ettinger.de.

Subject to change and errors.