

Article datasheet

Countersunk Screw ISO7046 M2x4 A2 Plain Stainless Steel Cross Recessed

Article-No.: 001.12.108



Image may be similar

Actuator Size:	Phillips PH1
DIN/ISO:	ISO7046
Drive Type:	Cross Recess / Phillips-H
Finish:	Plain
Head Diameter [mm]:	3.8
Head Height [mm]:	1.2
Head Shape:	Countersunk Head
Length [mm]:	4
Material:	Stainless Steel AISI 304 / A2
Material Group:	Stahl rostfrei
Thread Size:	M2
Weight:	0.12g
Conformities:	

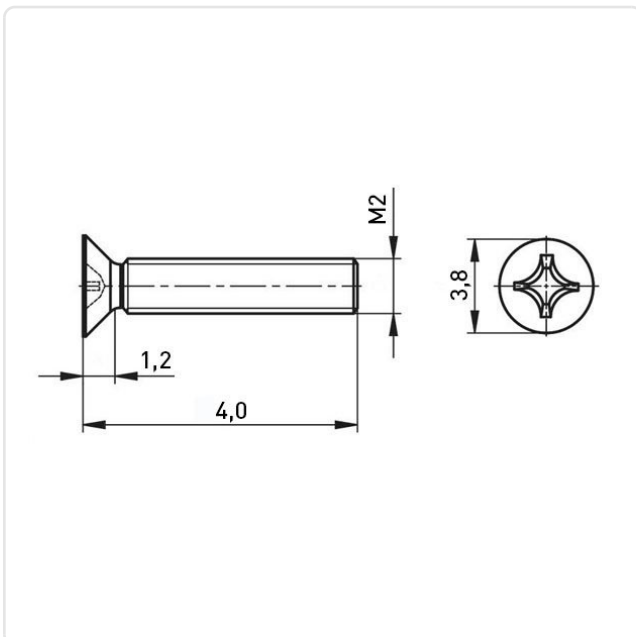

You can find all information on the web on our article detail page

[Countersunk Screw ISO7046 M2x4 A2 Plain Stainless Steel Cross Recessed](#)

Would you like individual advice?

We look forward to your email to products@ettinger.de.

Subject to change and errors.