

Article datasheet

Pan Head Screw ISO7045 M6x16 Steel 4.8 Nickel Plated Cross Recessed

Article-No.: 001.17.663



Image may be similar

Actuator Size:	Phillips PH3
DIN/ISO:	ISO7045
Drive Type:	Cross Recess / Phillips-H
Finish:	Nickel-Plated, 3 µm, E1E
Head Diameter [mm]:	12
Head Height [mm]:	4.6
Head Shape:	Pan Head
Length [mm]:	16
Material:	Steel 4.8, lead-free
Material Group:	Steel
Thread Size:	M6
Weight:	5.62g
Conformities:	

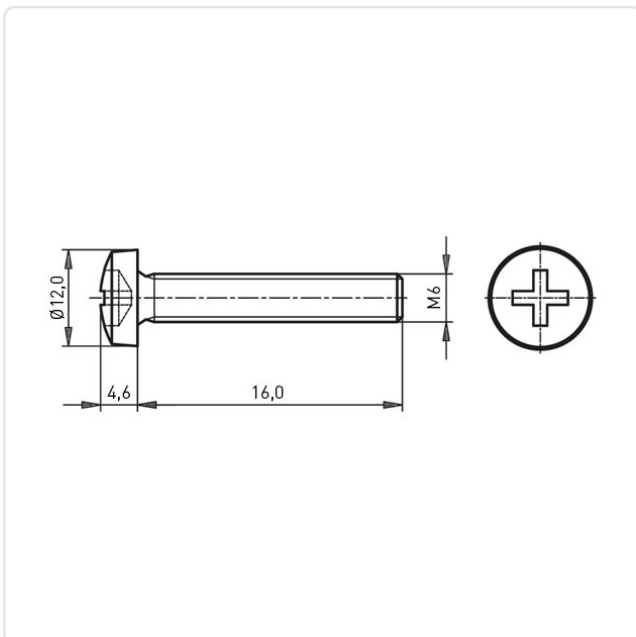

You can find all information on the web on our article detail page

[Pan Head Screw ISO7045 M6x16 Steel 4.8 Nickel Plated Cross Recessed](#)

Would you like individual advice?

We look forward to your email to products@ettinger.de.

Subject to change and errors.