

Article datasheet

Hexagon Head Screw ISO4017 M8x14 Steel 8.8 Zinc Plated

Article-No.: 082.75.711



Image may be similar

Actuator Size:	Hexagon Hex13
DIN/ISO:	ISO4017
Drive Type:	Hexagon
Finish:	Galvanized, Blue, 5 µm, A2K
Head Diameter [mm]:	13
Head Height [mm]:	5.3
Head Shape:	Hexagon Head
Length [mm]:	14
Material:	8.8
Material Group:	NULL
Thread Size:	M8
Weight:	9.87g
Conformities:	

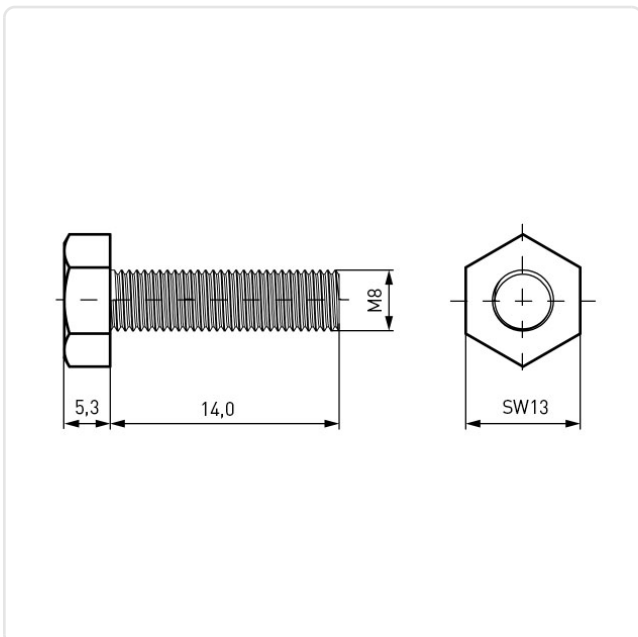

You can find all information on the web on our article detail page

[Hexagon Head Screw ISO4017 M8x14 Steel 8.8 Zinc Plated](#)

Would you like individual advice?

We look forward to your email to products@ettinger.de.

Subject to change and errors.